

Automatic Door Sensors



ADS-A Series PRODUCT MANUAL

For your safety, read and follow the considerations written in the instruction manual, other manuals and Autonics website.

The specifications, dimensions, etc. are subject to change without notice for product improvement. Some models may be discontinued without notice.

Features

- Adjustable hold time switch (2, 7, 15 sec)
- 4-step detection angle adjustment (7.5°, 14.5°, 21.5°, 28.5°)
- Adjustable sensing area (left / right area elimination)
- Power supply
 - : 24-240 VAC~ / 24-240 VDC= (universal AC / DC type),
 - 12-24 VAC~ / 12-24 VDC= (universal AC / DC type)
- Built-in microprocessor
- Max. sensing area : 2460 × 86 mm (installation height 2.7 m)

Safety Considerations

- Observe all 'Safety Considerations' for safe and proper operation to avoid hazards.
- ⚠ symbol indicates caution due to special circumstances in which hazards may occur.

⚠ Warning Failure to follow instructions may result in serious injury or death.

- 01. Fail-safe device must be installed when using the unit with machinery that may cause serious injury or substantial economic loss. (e.g., nuclear power control, medical equipment, ships, vehicles, railways, aircraft, combustion apparatus, safety equipment, crime/disaster prevention devices, etc.)**
Failure to follow this instruction may result in personal injury, economic loss or fire.
- 02. Use this product as secondary safety aid for door sensor.**
Failure to follow this instruction may result in personal injury or economic loss.
- 03. Since the purpose of this product is secondary safety aid, please use it with another door sensor.**
 - Although install this product near the sensing area, object in the nearest area from the door can not be detected. It is hard to detect kids or elders consecutively, they can be caught by the auto door.
 - Keep opened as much as the holding time you set. Since door closes after the holding time, the people can be caught by the auto door.
- 04. Do not connect, repair, or inspect the unit while connected to a power source.**
Failure to follow this instruction may result in fire.
- 05. Do not use the unit in the place where flammable/explosive/corrosive gas, high humidity, direct sunlight, radiant heat, vibration, impact, or salinity may be present.**
Failure to follow this instruction may result in explosion or fire.
- 06. Check 'Connections' before wiring.**
Failure to follow this instruction may result in fire.
- 07. Do not disassemble or modify the unit.**
Failure to follow this instruction may result in fire.

⚠ Caution Failure to follow instructions may result in injury or product damage.

- 01. Use the unit within the rated specifications.**
Failure to follow this instruction may result in fire or product damage.
- 02. Use a dry cloth to clean the unit, and do not use water or organic solvent.**
Failure to follow this instruction may result in fire or electric shock.
- 03. In case eliminating right/left sensing area, install the product in place where an object enters from the front.**
If enter from the side, door does not open.
- 04. Do not use a load over the range of rated relay specification.**
Failure to follow this instruction may result in fire, relay broken, contact melt, insulation failure or contact failure.

Cautions during Use

- Follow instructions in 'Cautions during Use'. Otherwise, It may cause unexpected accidents.
- 12 - 24 VDC=, 12 - 24 VAC~ power supply should be insulated and limited voltage / current or Class 2, SELV power supply device.
- Use the product, 3 sec after supplying power.
When using separate power supply for the sensor and load, supply power to sensor first.
- When using switching mode power supply (SMPS) to supply the power, ground F.G. terminal and connect a condenser between 0V and F.G. terminal to remove noise.
- When connecting a DC relay or other inductive load, remove surge by using diodes or varistors.
- Wire as short as possible and keep away from high voltage lines or power lines, to prevent surge and inductive noise.
- This unit may be used in the following environments.
 - Indoors (in the environment condition rated in 'Specifications')
 - Altitude max. 2,000 m
 - Pollution degree 3
 - Installation category II

Ordering Information

This is only for reference, the actual product does not support all combinations. For selecting the specified model, follow the Autonics website.

ADS - A ①

① Power supply

F: 24-240 VAC~ / VDC==
E: 12-24 VAC~ / VDC==

Product Components

- Product × 1
- Instruction manual × 1
- Mounting connector cable (2.5 m) × 1
- Mounting screw × 2
- Mounting template × 1

Cautions for Installation

- Install the unit correctly with the usage environment, location, and the designated specifications.
- This product is not qualified for waterproof. Please install this without direct contacting to rain or snow etc. It may cause a short circuit or breakdown.
- Do not install this unit in the place where having reflecting light like sunlight directly reaches. It may does not operate normally.
- Do not install this unit in the place where smoke or vapor occurs. It may not operate normally.
- If there is a movable object in the sensing area, it may cause malfunction by sensing the object because of natural phenomenon like wind etc.
- The sensing lens must be installed face to the door's threshold. If it faces the wall or roof, it may not operate normally.
- Do NOT impacts with a hard object or excessive bending of the wire lead-out. It may cause damage the water resistance.

Recommended Installation

1. Attach mounting template at mounting position.

- Drill Ø 3.4 mm hole based on mounting template.
- In case of wiring the cable on the wall to hide the cable, drill Ø 9 mm hole. In case of using outlet to wire as form of the exposed cable, take off point. In case of without the cable outlet, the unit must be installed at inner position of door. It may give an electric shock or damage to the equipment when the water inflows through cable outlet.
- Install the unit after removing a mounting template.

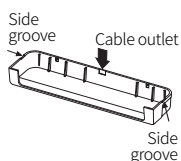

2. Please fix this unit with screw bolt after removing protection cover off.

- Pulling left thumb toward ①, key lock will be released and pull right thumb toward ②, protection cover and body will be detached.
- Do not put excessive tightening torque on screw bolt when mount this unit. It may result in fixing hole damage.



3. Connect the code part of the extension cable to main control part.

- Please install the connector in order to connect with the body.

4. Connect the connector of the body and the connector of the extension cable.

- Plug in the connector of the extension cable and the connector of the unit completely. The unit may not work normally by inferior contact.
- It can be disconnected by pushing this position. (gray: power line, white: signal line)

Dimensions

- Unit: mm, For the detailed drawings, follow the Autonics website.

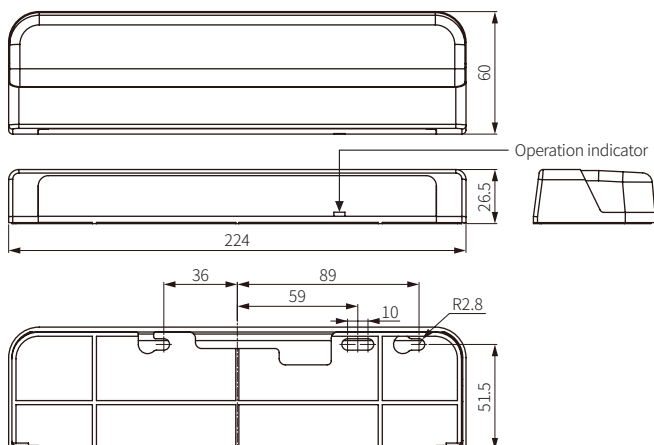

Specifications

Model	ADS-A□
Mounting height	2.0 to 2.7 mm ⁰¹⁾
Sensing area	9-point
Sensing method	Infrared reflection method
Output holding time	Time delay ≈ 0.5 sec
Stationary sensing time	2 sec, 7 sec, 15 sec (holding time setting switch)
Interference prevention	H, L (interference prevention switch)
Adjust angle	7.5°, 14.5°, 21.5°, 28.5° (angle adjustment lever)
Eliminate right / left sensing area	(1, 2, 3 area), (7, 8, 9 area) (eliminating right / left sensing area lever)
Light source	Infrared chip diode (modulated)
Indicator	Operation indicator (orange, green, red)
Approval	FH
Weight	≈ 320 g

01) In case of installing the unit higher than 2.7 m height, the unit may not detect small children. In case of installing the unit lower than 2.0 m height the unit may not work normally.

Power supply	ADS-AF: 24 - 240 VAC~, 50 / 60 Hz, 24 - 240 VDC== (ripple P-P: ≤ 10%) ADS-AE: 12 - 24 VAC~, 50 / 60 Hz, 12 - 24 VDC== (ripple P-P: ≤ 10%)
Power consumption	ADS-AF: ≤ 4 VA (≤ 240 VAC~ at 50 / 60 Hz) ADS-AE: ≤ 2 VA (≤ 24 VAC~ at 50 / 60 Hz)
Control output	Relay contact output
Relay contact capacity ⁰¹⁾	50 VDC== 0.1 A (resistive load)
Relay contact composition	1a
Relay life cycle	Mechanical: ≥ 20,000,000 times, electrical: ≥ 50,000 times
Insulation resistance	≥ 20 MΩ (500 VDC== megger)
Noise immunity	± 2,000 VDC== the square wave noise (pulse width: 1 μs) by the noise simulator
Dielectric strength	Between the charging part and the case: 1,000 VAC~ 50 / 60 Hz for 1 minute
Vibration	1.5 mm double amplitude at frequency of 10 to 55 Hz in each X, Y, Z direction for 2 hours
Shock	100 m/s ² (≈ 10 G) in each X, Y, Z direction for 3 times
Ambient illumination (receiver)	Sunlight: ≤ 3,000 lx, incandescent lamp: ≤ 3,000 lx
Ambient temperature	-20 to 50 °C, storage: -20 to 70 °C (no freezing or condensation)
Ambient humidity	35 to 85 %RH, storage: 35 to 85 %RH (no freezing or condensation)
Protection	IP50 (IEC standard)
Connection	Cable connector type
Material	Case: ABS, lens: acryl, lens cover: acryl

01) Do not use the load which is beyond the rated capacity of contact point of relay. It may cause bad insulation, contact fusion, bad contact, relay breakdown, and fire etc.

Unit Descriptions

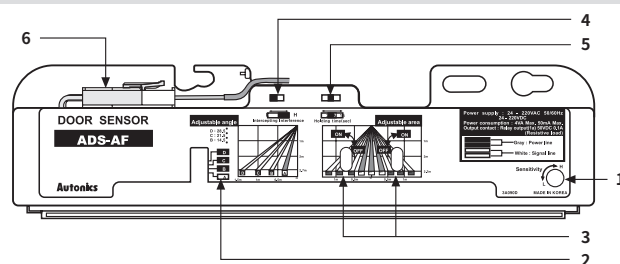

1	Sensitivity adjustment switch	2	Angle adjustment lever	3	Eliminating right/left sensing area lever
4	Interference prevention switch	5	Holding time setting switch	6	Body connector

Operation Indicator

Entry activation	Power ON	Out of the sensing area ⁰¹⁾	Enter the sensing area	Stationary sensing	Out of the sensing area ⁰²⁾
Operation indicator	Orange	ON	OFF	OFF	OFF
	Green	OFF	ON	OFF	ON
	Red	OFF	OFF	ON	OFF
Output contact	OFF	OFF	ON	OFF after the holding time	OFF after 0.5 sec.

01) It operates in the normal. None of the person or the object is in the sensing area.

02) The state after the person or object has passed.

Sensitivity Adjustment

- Please check the normal operation by turning the power ON and OFF after finishing the sensitivity setting. Otherwise, it may not operate normally because the setting is changed before and after the sensitivity adjustment.

Sensitivity adjustment switch	Description
	Even though there is a person in the sensing area, the sensor does not operate, turning the adjuster up to H. The sensitivity will be increased.
	Even though there is not a person in the sensing area, the sensor operates, turning the adjuster up to L. The sensitivity will be decreased.

Settings for the Sensing Area

■ Sensing area

- The all area and emitter spot width vary depending on the installation height.

Installation height	2 m	2.2 m	2.5 m	2.7 m
Sensing area				
4, 5, 6 area	530 mm	580 mm	660 mm	710 mm
All area	1,820 mm	2,000 mm	2,280 mm	2,460 mm
emitter spot width	64 mm	70 mm	80 mm	86 mm

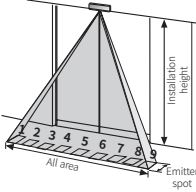

■ Width of the sensing area

- You can adjust the width of entire sensing areas via the angle adjustment lever per 7° (7.5 to 28.5°).
- There is a risk of getting caught in the door. You must use together with the door side sensor (ADS-SE1/2, sold separately).

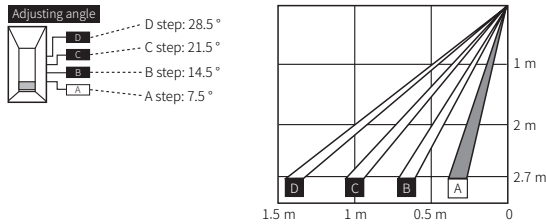

■ Left / right of the sensing area

- Sensing area width 1, 2, 3 can be eliminated by the left lever, 7, 8, 9 by the right lever. But the elimination of sensing area can be normally operated in installation height.
- It is not able to eliminate certain one area like elimination of area 1 or 7.
- Use the unit as removing non-sensing area by the lever adjusting width in the narrow sensing area. You can use both the left and right side of the lever at the same time.
- When eliminating the left and right side of the sensing areas, install the unit in a place where the entrant comes from the front. If the entrant approaches from the lateral direction, decreasing sensing performance so that there is a risk of hitting the door that does not open.

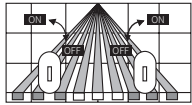

Turn the adjuster till stopping it toward the arrow direction by a (-) screwdriver.

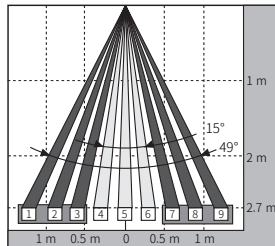

Switch Setting

■ Interference prevention switch

- When several door sensors are installed simultaneously without considering any interference prevention, it may cause malfunction by another door sensor even though no moving object exists.
- If sensing area of the door sensors is overlapped, set each switch in difference or install the unit on non-overlapped sensing area.

■ Holding time setting switch

- When an object stays in the sensing area, output is kept in ON status during set holding time after output holding time. After set holding time, output turns OFF and the door closes.
- It can be set by the holding time setting switch (2, 7, 15 sec selectable).

Troubleshooting

Malfunction	Cause	Troubleshooting
It is not work.	Power voltage	Check the power cable and adjust power voltage.
	Cable cut, disconnection	Check connector and wiring.
Sometimes it does not work.	The sensing lens are unclean	Clean the lens with dry tissue and natural detergent.
	There are moving objects.	Check surrounding environment for installation.
The door is opened even if the people do not enter in the sensing area.	By occurring sudden change of sensing area.	Check surrounding environment for installation.
	Sensing area is overlapped.	Install the unit to avoid overlap for sensing area. Set the switch intercepting interference.
	There is the equipment such as motor, neon lamp, generator, or high voltage line causing strong electric wave, noise.	Do not install the equipment causing strong electric wave, noise near the sensor.
	A drop of water is placed at the lens.	Remove a drop of water.