

Human/Machine Interfaces

Magelis™ XBTN and XBTR Small panels

Catalog

March 2017

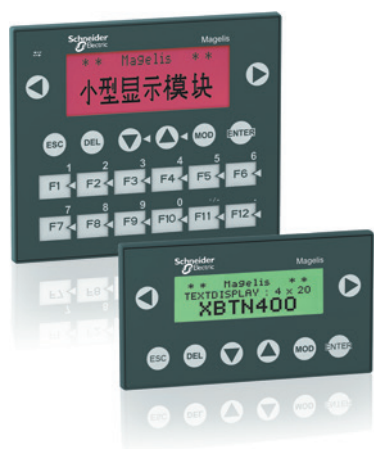

Quick access to Product information

Select your Catalogue, your Training

Digi-Cat

The complete digital catalogue for industrial automation



Makes your choice easy every day, everywhere!



With just 3 clicks, you can reach the 7,000 pages of the Industrial Automation & Control catalogue, in both English and French.

- Digi-Cat is available on a USB key (for PC). To get your Digi-Cat, please contact your local center
- Download Digi-Cat from this address:

<http://digi-cat.schneider-electric.com/download.html>

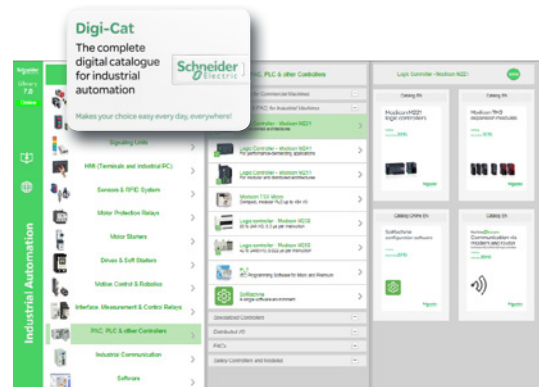

Find your training

- Find the right training for your needs
- Locate the training center with the selector tool, using this address:

<http://www.schneider-electric.com/b2b/en/services/training/technical-training.jsp>

then click on

Find your training center

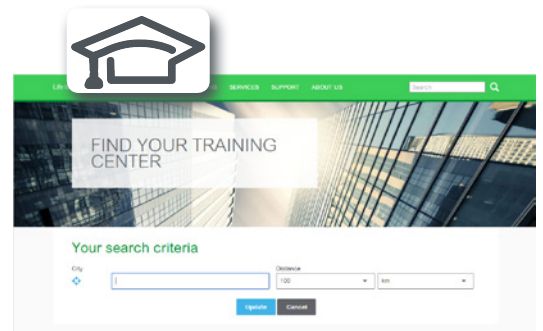

Life Is On



General contents

Magelis™ XBTN and XBTR Small panels

Selection guide	page 2
■ Presentation	page 4
■ Architecture	page 5
■ Functions	page 6
■ Description	
□ Magelis XBTN Small panels with keypad	page 7
□ Magelis XBTR Small panels with keypad	page 8
■ References	
□ Magelis XBTN Small panels with keypad	page 9
□ Magelis XBTR Small panels with keypad	page 10
□ Separate components for Magelis XBTN and XBTR	page 11
■ Substitution	page 15
■ HMI configuration software	
Selection guide	page 18
■ Product reference index	page 20

Applications		Display of text messages and/or semi-graphic pages
Type of terminal		Small panels with keypad
		
Display	Type	Green backlit monochrome LCD, height 5.5 mm or Green, orange or red backlit monochrome LCD, height 4.34...17.36 mm
	Capacity	2 lines of 20 characters or 1 to 4 lines of 5 to 20 characters (monochrome)
Data entry		Via keypad with ■ 8 keys (4 customizable)
Memory capacity	Application	512 KB Flash
	Expansion	–
Functions	Maximum number of pages	128/200 application pages 256 alarm pages
	Variables per page	40...50
	Representation of variables	Alphanumeric
	Recipes	–
	Curves	Yes
	Alarm logs	Yes (1)
	Real-time clock	Access to the PLC real-time clock
	Alarm relay	–
	Buzzer	–
	Communication	Asynchronous serial link
Downloadable protocols		Uni-TE, Modbus and for PLC brands: Allen-Bradley, Omron, Mitsubishi, Siemens
Printer link		RS-232C serial link (1)
USB ports		–
Networks		–
Development software		Vijeo Designer Lite (on Windows 2000 Professional, Windows XP Professional and Windows Vista Business 32-bit)
Operating system		Magelis
References		XBTN●●●●
Page		9 (1) Depending on model.

Applications		Display of text messages and/or semi-graphic pages Control and configuration of data
Type of terminal		Small panels with keypad
		
Display	Type	Green, orange or red backlit monochrome LCD height 4.34...17.36 mm
	Capacity	1 to 4 lines of 5 to 20 characters (monochrome)
Data entry		Via keypad with ■ 12 function keys or numeric entry (depending on context) ■ 8 service keys
Memory capacity	Application	512 KB Flash
	Expansion	–
Functions	Maximum number of pages	128/200 application pages 256 alarm pages
	Variables per page	40...50, bargraph, buttons, LEDs
	Representation of variables	Alphanumeric
	Recipes	–
	Curves	Yes
	Alarm logs	Yes
	Real-time clock	Access to the PLC real-time clock
	Alarm relay	–
	Buzzer	–
	Communication	Asynchronous serial link
Downloadable protocols		Uni-TE, Modbus and for PLC brands: Allen-Bradley, Omron, Mitsubishi, Siemens
Printer link		RS-232C serial link (1)
USB ports		–
Networks		–
Development software		Vijeo Designer Lite (on Windows 2000 Professional, Windows XP Professional and Windows Vista Business 32-bit)
Operating system		Magelis
References		XBTR●●●
Page		10

Presentation



XBTR411

XBTR400

Magelis XBTR and Magelis XBTR terminals are used to display messages and variables.

The various keys can be used to:

- Modify variables
- Control a device
- Navigate within the operator dialogue application

Alarm messages can be printed out from models that have a printer port.

Operation



"Entry" customization

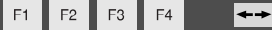

"Control" customization

All Magelis terminals have the same user interface:

- 2 service keys (◀, ▶) configurable for contextual link or control, on XBTR/R ("entry"/"control" modes)
- 2 service keys (ESC, ENTER), non-configurable
- These keys are complemented by:
 - On XBTR terminals: 4 customizable service keys which can be configured as function keys ("control" mode) or service keys ("entry" mode)
 - On XBTR terminals: 4 service keys, non-configurable, and 12 function or numeric entry keys (depending on context)

Configuration

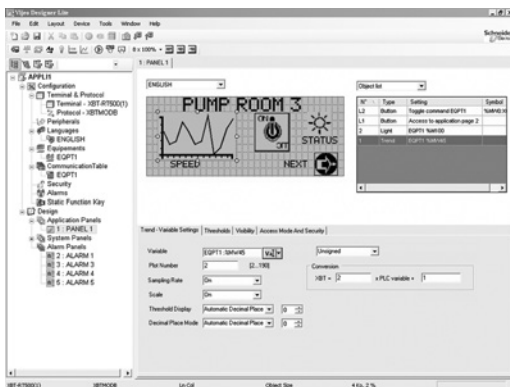

Vijeo Designer Lite

Magelis terminals can be configured using Vijeo Designer Lite software in a Windows 2000 Professional, XP Professional or Vista Business (32-bit) environment.

Vijeo Designer Lite software uses the concept of pages: each page can be viewed in its entirety. A 2, 4 or 10-line window, depending on the terminal model to be configured, is used to view the screen of this virtual terminal.

The symbol databases of TwidoSoft, PL7 and Concept applications can be imported into the Vijeo Designer Lite operator dialogue application. For more information on Vijeo Designer Lite software, see page 18.

Communication

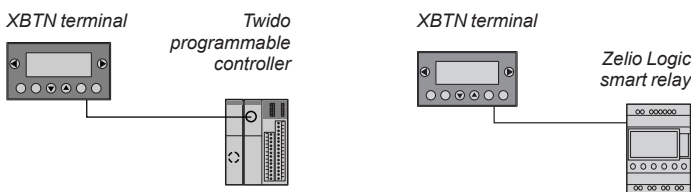

Examples of connections

XBTR and XBTR terminals communicate with PLCs via an integrated serial link in either point-to-point or multidrop mode, depending on the model.

The communication protocols used are those of Schneider Electric PLCs (Uni-TE, Modbus) and those of the main manufacturers on the market.

XBTR401 and XBTR411 terminals communicate with Zelio Logic smart relays via a direct connection cable and using the Zelio protocol, which is included in Vijeo Designer Lite V1.3.

Architecture

Magelis operator dialogue terminals communicate with automation system equipment:

- Via serial link
- By means of integration into an Ethernet TCP/IP architecture

Communication via serial link

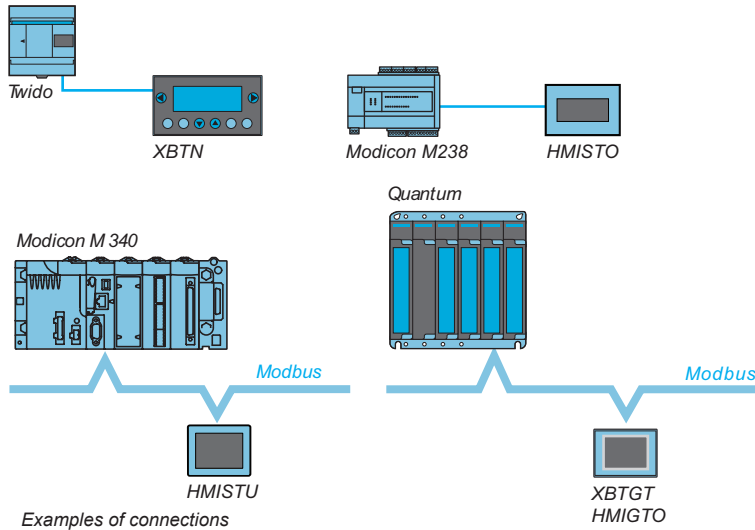

All Magelis terminals feature an integrated RS 232 C or RS 422/485 asynchronous serial link.

Use of the Uni-TE or Modbus protocol makes it easy to set up communication with Schneider Electric PLCs.

Third-party protocols enable connection to PLCs offered by major manufacturers on the market:

- DF1, DH485 for Allen-Bradley PLCs
- SysmacWay for Omron PLCs
- MPI/PPI for Siemens Simatic S7 PLCs
- Mitsubishi Melsec FX PLC

Integration into an architecture with Ethernet TCP/IP network

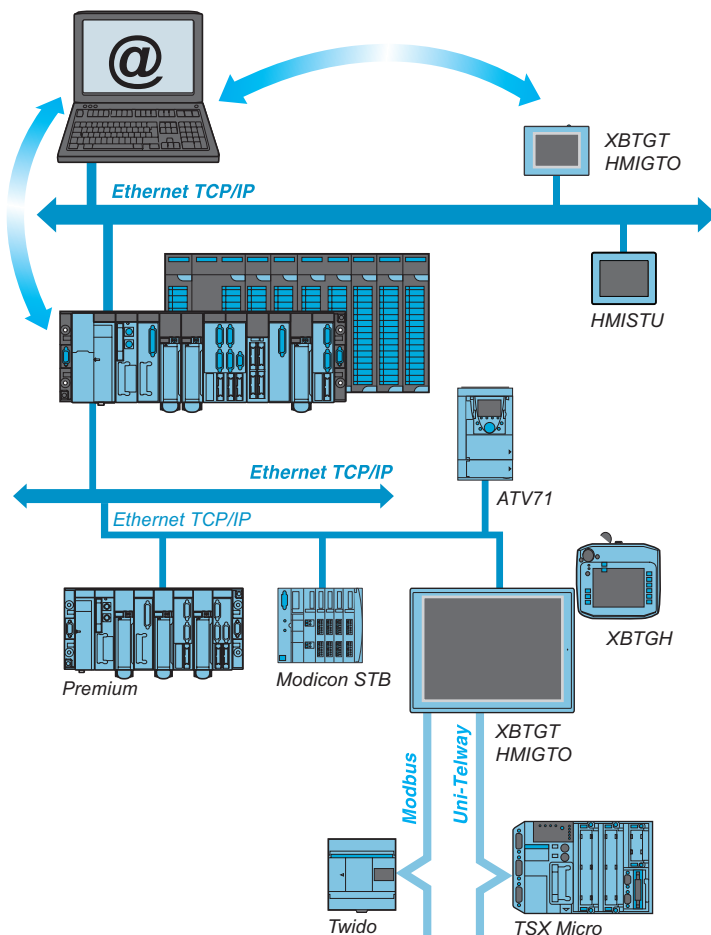

Automation platforms provide transparent routing of Uni-TE or Modbus messages from a TCP/IP network to a Uni-TE or Modbus network and vice versa.

The various services offered for the terminals are:

- **Modbus TCP/IP messaging** (for XBTGH, XBTGT and HMIGTO, access with Ethernet TCP/IP Modbus protocol)
- **Browse function** with standard PC
- **Web Gate function**: Diagnostics to remotely control the application
- **FTP server**: Transfer of data files with the terminal
- **Data Sharing function**: Data exchange on Ethernet between 8 terminals (maximum)
- **E-mail function**

Functions

On their front panel, XBTN/R terminals have function keys and service keys (depending on how the keys have been configured for “control” and “entry” modes).

“F” function keys

The function keys are defined for the whole application.

The number of function keys depends on the model:

- F1, F2, F3, F4 on XBTN
- F1...F12 on XBTR

They can have the following functions:

- Accessing a page
- Impulse command
- “Toggle” command
- ...

In addition, with the XBTR terminal, if the **MOD** key is pressed, the 12 function keys become numeric entry keys **1...0**, **+/-** and **..**

Service keys

Service keys **◀**, **ESC**, **DEL**, **▼**, **▲**, **MOD**, **ENTER** and **▶** are used to modify the parameters of the automation system.

They perform the following actions:

- ESC** Cancel an entry, suspend or stop a current action, go up one level in a menu
- DEL** Delete the character selected in entry mode
- MOD** Select the variable field in which to enter data. Enable entry in the next field, on each press, from left to right and top to bottom.
- ENTER** Confirm a selection or entry, acknowledge an alarm

The “arrow” keys are used to:

- ◀ ▶**
 - Change the page within a menu
 - Display the current alarms
 - Change a digit in a variable field in which data is being entered
 - Activate the function associated with a functional link
- ▼ ▲**
 - Move up and down within a page (XBTN40●)
 - Select the value of a digit
 - Select a value from a list of choices
 - Increment or decrement the value of a variable field

Description of XBTN terminals

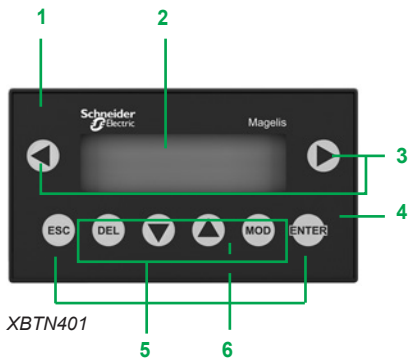
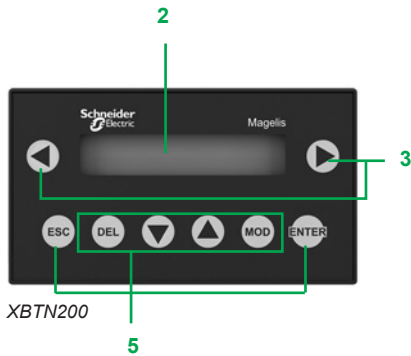

XBTN terminals comprise:

On the front panel

- 1 A communication monitoring lamp (model XBTN401)
- 2 A backlit ultra-bright LCD display: 122 x 32 pixels (matrix) or 2 lines of 20 characters (alphanumeric)
- 3 Two non-customizable command or contextual link keys
- 4 An "alarm" LED (model XBTN401)
- 5 Six service keys, four of which (framed) can be configured as function keys and customized using labels
- 6 Two system LEDs in entry mode or four LEDs that can be controlled by the PLC in control mode (model XBTN401)

Supplied separately

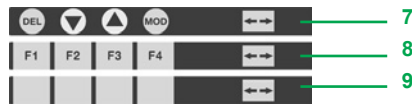

- A sheet of labels comprising:
 - 7 An "entry" label
 - 8 A "control" label (F1, F2, F3 and F4)
 - 9 Four customizable blank labels
- Two spring clips for fixing the terminal on the panel

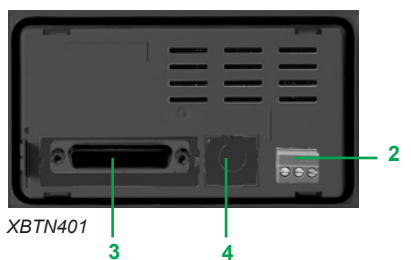

On the rear panel

XBTN200/N400 terminals

- 1 An RJ45 connector for point-to-point serial link and connection for 5 V $\overline{\text{DC}}$ power supply (supplied by PLC)

XBTN401/N410/NU400 terminals

- 2 A removable screw terminal block for 24 V $\overline{\text{DC}}$ external power supply
- 3 A 25-way female SUB-D connector for multidrop serial link
- 4 An 8-way female mini-DIN connector for serial printer link (model XBTN401)

Description of XBTR terminals with keypad

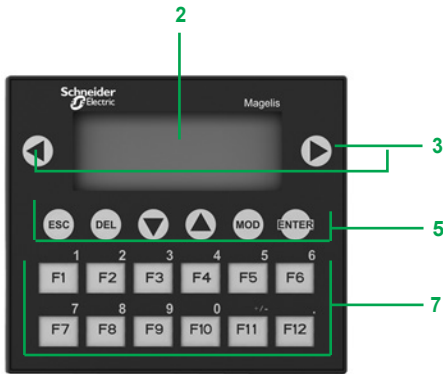

XBTR400

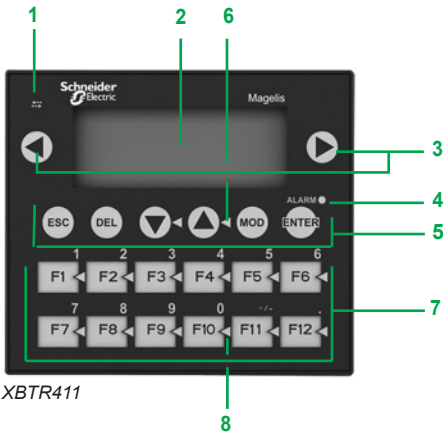

XBTR411

XBTR terminals comprise:

On the front panel

- 1 A communication monitoring LED (model XBTR411)
- 2 A backlit ultra-bright LCD display: 122 x 32 pixels (matrix)
- 3 Two non-customizable command or contextual link keys
- 4 An "alarm" lamp (model XBTR411)
- 5 Six service keys
- 6 Two system LEDs (model XBTR411)
- 7 Twelve function or numeric entry keys (depending on context), customizable using labels
- 8 Twelve lamps (for model XBTR411), that can be controlled by the PLC

Supplied separately

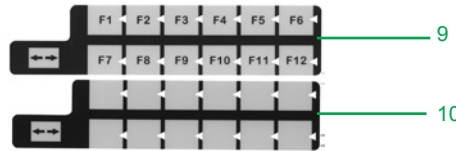

- A sheet of labels comprising:
 - 9 A "control" label (F1...F12)
 - 10 Two customizable blank labels
- Four spring clips for fixing the terminal on the panel

On the rear panel

XBTR400 terminals

- 1 An RJ45 connector for point-to-point serial link and connection for 5 V $\bar{\bar{}}$ power supply (supplied by PLC)

XBTR410/R411 terminals

- 2 A removable screw terminal block for 24 V $\bar{\bar{}}$ external power supply
- 3 A 25-way female SUB-D connector for multidrop serial link
- 4 An 8-way female mini-DIN connector for serial printer link (model XBTR411)



XBTR400

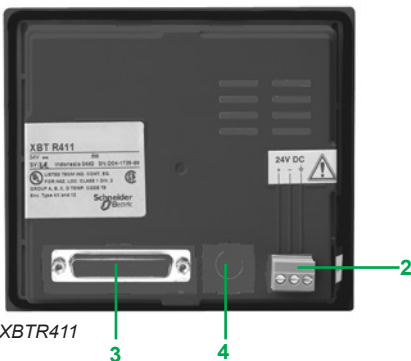

XBTR411



XBTN200



XBTN400/N410/NU400



XBTN401

Magelis XBTN Small panels

Downloadable exchange protocol	Compatible PLCs	Supply voltage	Type of screen	Reference	Weight kg/lb
Terminal with 2 lines of 20 characters (with alphanumeric screen)					
Uni-TE, Modbus	Twido, Nano, TSX Micro, Premium, Modicon M340	5 V $\overline{\text{---}}$ via PLC terminal port	Green backlit LCD	XBTN200	0.360/ 0.794
Terminals with 4 lines of 20 characters (with matrix screen)					
Uni-TE, Modbus	Twido, Nano, TSX Micro, Premium, Modicon M340	5 V $\overline{\text{---}}$ via PLC terminal port	Green backlit LCD (122 x 32 pixels)	XBTN400	0.360/ 0.794
	Twido (1), Nano, TSX Micro, Premium, TSX series 7, Momentum, Quantum Other Modbus slave devices, Modicon M340	24 V $\overline{\text{---}}$ external supply	Green backlit LCD (122 x 32 pixels)	XBTN410	0.380/ 0.838
Uni-TE, Modbus	Twido (1), Nano, TSX Micro, Premium, TSX series 7, Momentum, Quantum Other Modbus slave devices, Modicon M340	24 V $\overline{\text{---}}$ external supply	Green, orange and red backlit LCD (2) (122 x 32 pixels)	XBTN401	0.380/ 0.838
Zelio	Zelio Logic				
Modbus	TeSys model U motor starters (3) Altivar drives	24 V $\overline{\text{---}}$ external supply	Green backlit LCD (122 x 32 pixels)	XBTNU400	0.380/ 0.838

Software

Description	Operating system	Reference
Configuration software Vijeo Designer Lite	Windows 2000 Professional, XP Professional and Vista Business (32-bit)	See page 18

Accessories (4)

Description	Details	For use with	Reference	Weight kg/lb
Accessory for flush mounting	Kit for applications requiring a higher degree of protection or customization of the control desk, using flat inner insulation (not included)	All XBTN	XBTZN01	–
Protective sheets	10 peel-off sheets	All XBTN	XBTZN02	–
Sheets of re-usable labels	10 sheets of 6 labels	XBTN200/400 XBTN401 XBTNU400	XBLYN00 XBLYN01	– –
Mechanical adaptors for substitution of XBTH	From XBTH0●2●1/H0●1010 to XBTN410 From XBTH811050 to XBTN410	–	XBTZNCO	–

Connection cables and accessories (5)

Description	Compatibility	Types of connector	Physical link	Protocol	Length	Reference	Weight kg/lb
Adaptor cable	XBTN200 XBTN400 (6)	RJ45-RJ45	RS 232C RS 485	Modbus, Uni-TE	0.1 m	XBTZN999	–

(1) Connection via integrated port or optional serial port on the Twido programmable controller.

(2) Also available with 4 signalling LEDs.

(3) Factory preloaded application for monitoring, diagnostics and adjustment of 1 to 8 TeSys model U motor starters.

(4) For other accessories, see page 11.

(5) For other connection cables and accessories, see pages 11 to 14.

(6) Adaptor **XBTZN999** is designed for use with **XBTN200/N400** terminals (new version) and cable **XBTZ978** (replaced by **XBTZ9780**), or with **XBTN200/N400** terminals (old version) and the new **XBTZ9780** cable.

Note: The new version of the XBTN terminal can be distinguished from the old version by its exterior, as it features the Schneider Electric logo on the front panel (on the left above the screen).

521377

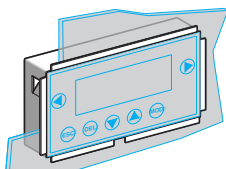

XBTZN01

521373

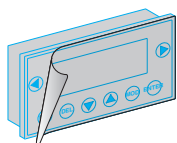

XBTZN02



XBTR400/R410



XBTR411

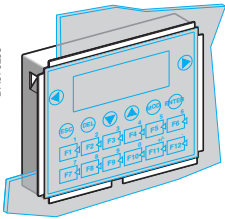

XBTRZ01

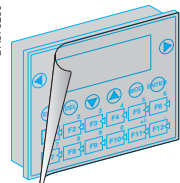

XBTRZ02

Magelis XBTR Small panels

Downloadable exchange protocol	Compatible PLCs	Supply voltage	Type of screen	Reference	Weight kg/lb
Terminals with 4 lines of 20 characters (with matrix screen)					
Uni-TE, Modbus	Twido, Nano, TSX Micro, Premium, Modicon M340	5 V $\overline{\text{---}}$ via PLC terminal port	Green backlit LCD (122 x 32 pixels)	XBTR400	0.550/1.213
	Twido (1), Nano, TSX Micro, Premium, TSX series 7, Momentum, Quantum Other Modbus slave devices, Modicon M340	24 V $\overline{\text{---}}$ external supply	Green backlit LCD (122 x 32 pixels)	XBTR410	0.550/1.213
Uni-TE, Modbus	Twido (1), Nano, TSX Micro, Premium, TSX series 7, Momentum, Quantum Other Modbus slave devices, Modicon M340	24 V $\overline{\text{---}}$ external supply	Green, orange and red backlit LCD (2) (122 x 32 pixels)	XBTR411	0.550/1.213
Zelio	Zelio Logic				

Software

Description	Operating system	Reference	
Configuration software Vijeo Designer Lite	Windows 2000 Professional, XP Professional and Vista Business (32-bit)	See page 18	–

Accessories (3)

Description	Details	For use with	Reference	Weight kg/lb
Accessory for flush mounting	Kit for applications requiring a higher degree of protection or customization of the control desk, using flat inner insulation (not included)	All XBTR	XBTRZ01	–
Protective sheets	10 peel-off sheets	All XBTR	XBTRZ02	–
Sheets of re-usable labels	10 sheets of 6 labels	XBTR400/R410	XBLYR00	–
		XBTR411	XBLYR01	–
Mechanical adaptor for substitution of XBTP	From XBTP01●010/P02●010 to XBTR410	–	XBTRZCO	–
	From XBTP02●110 to XBTR411			

(1) Connection via integrated port or optional serial port on the Twido PLC.

(2) Also available with 16 signalling LEDs.

(3) For other accessories, see pages 11 to 14.

Operator dialogue terminals

Separate components for Magelis XBTN and XBTR Small panels

Accessories ⁽¹⁾				
Type	Compatibility	Sold in lots of	Unit reference	Weight kg/lb
External 5 V adaptor (2)	XBTN200/N400 XBTR400	1	XBTZRTPW	–
Spring clips (replacement parts)	XBTN/R	12	XBTZ3002	0.200/ 0.440
Power supply connector (replacement parts)	XBTN/R	10	XBTZ3004	0.200/ 0.440

Connection to PCs and printers					
Used	Compatibility	Length m/ft	Peripheral side connector	Reference	Weight kg/lb
Cables for PC connection, RS 232C serial port	XBTN401/N410/NU400 XBTR410/R411	2.5/ 8.20	9-way male SUB-D	XBTZ915	0.200/ 0.440
	XBTN200/N400/R400	2.5/ 8.20	9-way male SUB-D and mini-DIN (PS/2)	XBTZ945	0.200/ 0.440
USB cable for PC connection (3)	XBTN/R	–	USB type A male	TSXCUSB485	–
XBT adaptor for USB cable	XBTN/R	2/ 6.56	Set of 2 cables (RJ45/RJ45 RJ45/25-way SUB-D)	XBTZ925	–
Serial printer cables	XBTN/R	2.5/ 8.20	25-way female SUB-D	XBTZ926	0.220/ 0.485

(1) For other connection cables and accessories, see pages 11 to 14.

(2) Use a 5 V $\overline{\text{DC}}$ power supply: **ABL8MEM05040**

(3) Adaptor to be used with **XBTZ925** cable.

Operator dialogue terminals

Separate components for Magelis XBTN and XBTR Small panels

Cables for connecting Magelis terminals						
Type of PLC to be connected	Type of connector	Physical link	Protocol	Length m/ft	Reference	Weight kg/lb
Direct connection of XBTN/R (XBTN200/N400/R400) terminals to Schneider Electric PLCs						
Twido, Modicon Nano, Modicon TSX Micro, Modicon Premium	Mini-DIN	RS 485	Modbus/Uni-TE	2.5/8.20	XBTZ9780	–
				10/32.81	XBTZ9782 (1)	–
Modicon M340	RJ45	RS485	Modbus	2.5/8.20	XBTZ9980	–
				10/32.81	XBTZ9982 (1)	–
Direct connection of XBTN/R (XBTN410/N401/R410/R411) terminals to Schneider Electric PLCs						
Twido, Modicon Nano, Modicon TSX Micro, Modicon Premium	Terminal port, 8-way female mini-DIN	RS 485	Uni-TE (V1/V2) and Modbus	2.5/8.20	XBTZ968	0.180/0.397
				5/16.40	XBTZ9681	0.340/0.750
				2.5/8.20 (2)	XBTZ9680	0.170/0.375
Modicon Premium with TSXSCY2160●	25-way female SUB-D	RS 485	Uni-TE (V1/V2)	2.5/8.20	XBTZ918	0.230/0.507
Modicon Quantum	9-way male SUB-D	RS 232	Modbus	2.5/8.20	XBTZ9710	0.210/0.463
Modicon STB	HE13 (NIM)	RS 232	Modbus	2.5/8.20	XBTZ988	0.170/0.375
Modicon Momentum M1 (Port 1)	RJ45	RS 232	Modbus	2.5/8.20	XBTZ9711	0.210/0.463
Modicon M340	RJ45	RS 485	Modbus	2.5/8.20	XBTZ938	0.210/0.463
Direct connection of XBTN/R (XBTN401/R411) terminals to Schneider Electric PLCs via the 2nd mini-DIN serial port and Vijeo Designer Lite 1.3 minimum						
Zelio Logic	Programming port (specifically for Zelio Logic)	–	Zelio	3/9.84	SR2CBL08	–

(1) For XBTN200/N400/R400, use a cable with adaptor **XBTZRTPW** and a 5 V \pm power supply.

(2) Angled SUB-D connector.

Operator dialogue terminals

Separate components for Magelis XBTN and XBTR Small panels

Cables for connecting Magelis terminals (continued)							
Type of PLC to be connected	Type of connector	Physical link	Protocol	Length m/ft	Reference	Weight kg/lb	
Direct connection of XBT (XBTNU400/N410/N401/R410/R411) terminals to Schneider Electric motor starters and drives							
TeSys U, T ATV 312/32/61/71 variable speed drives ATS 48 starter Lexium 32, Preventa XPSMC	RJ45	RS 485	Modbus	2.5/ 8.20	XBTZ938	0.210/ 0.463	
Direct connection of XBT (XBTN200/N400/R400) terminals to Schneider Electric motor starters and drives (1)							
TeSys U, T ATV 312/32/61/71 variable speed drives ATS 48 starter Lexium 32, Preventa XPSMC	RJ45	RS 485	Modbus	2.5/ 8.20	XBTZ9980	–	
Direct connection of XBT (XBTN410/N401/R410/R411) terminals to third-party PLCs							
Allen-Bradley	SLC5	9-way male SUB-D	RS 232	DF1	2.5/ 8.20	XBTZ9730	0.210/ 0.463
	PLC5	25-way female SUB-D	RS 232	DF1	2.5/ 8.20	XBTZ9720	0.210/ 0.463
	Micro-logix	Micro-logix 1000	RS 232	DF1	2.5/ 8.20	XBTZ9731	0.210/ 0.463
				DH485	2.5/ 8.20	XBTZ9732	–
Mitsubishi	FX	8-way female mini-DIN	RS 232/ RS 422 converter	Melsec FX	2.5/ 8.20	XBTZ980	–
Omron	CPM1, CPM2, CJ1, CS1	9-way male SUB-D	RS 232	Sysmacway	2.5/ 8.20	XBTZ9740	0.210/ 0.463
Siemens	S7 (PG)	9-way male SUB-D	RS 485	PPI	2.5/ 8.20	XBTZ9721	0.210/ 0.463

(1) For Magelis XBTN200/N400/R400 use a cable with adaptor XBTZRTPW and a 5 V \pm power supply.

Operator dialogue terminals

Separate components for Magelis XBTN and XBTR Small panels

Cables for connecting Magelis terminals (continued)					
Bus and network connections for XBTN410/N401/R410/R411 terminals					
Type of bus/network	Tap-off units	Type of connector	Length m/ft	Reference	Weight kg/lb
Uni-Telway serial link	Subscriber socket TSXSCA62	15-way female SUB-D	1.8/ 5.91	XBTZ908	0.240/ 0.529
			Connection box TSXPACC01	8-way female mini-DIN	2.5/ 8.20
	5/ 16.40	XBTZ9681			0.340/ 0.750
	10/ 32.81	XBTZ9686			–
	20/ 65.62	XBTZ9687			–
	25/ 82.02	XBTZ9688			–
	Modbus serial link	Subscriber socket TSXSCA64	15-way female SUB-D	1.8/ 5.91	XBTZ908
8-port Modbus splitter box LU9GC3, Modbus tap-off, TWDXCAISO, TWDXCAT3RJ		RJ45	2.5/ 8.20	XBTZ938	0.210/ 0.463

Equivalent product table - XBTP to XBTR terminals

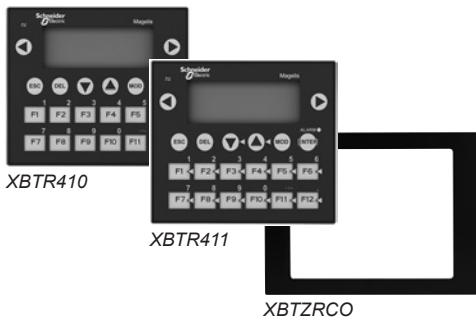

Old range XBTP	XBTR range	Mechanical adaptor (1)
XBTP011010	XBTR410	XBTRZRCO
XBTP012010	XBTR410	XBTRZRCO
XBTP021010	XBTR410	XBTRZRCO
XBTP021110	XBTR411	XBTRZRCO
XBTP022010	XBTR410	XBTRZRCO
XBTP022110	XBTR411	XBTRZRCO

Equivalent product table - Cables for connection to Schneider Electric products

Summary		
Old range XBTP	XBTR range	
Type of link	Type of link	Cable
Serial port, 25-way SUB-D RS 232C/RS 485/RS 422	Serial port, 25-way SUB-D RS 232C/RS 485	Existing cable (see below)
Printer port, 9-way SUB-D (model XBTP02●110)	Printer port, 8-way mini-DIN (model XBTR411)	XBTZ926 (new cable)

Old range XBTP				XBTR range			
Type of terminal	Type of link	Length	Reference	Type of terminal	Type of link	Length	Reference
Twido, Modicon TSX Micro, Modicon Premium , 8-way mini-DIN terminal port, Uni-TE (V1/V2), Modbus protocol							
XBTP	RS 485 serial port,	2.5 m	XBTZ968	XBTR	RS 485 serial port,	2.5 m	XBTZ968
	25-way SUB-D	5 m	XBTZ9681		25-way SUB-D	5 m	XBTZ9681
		2.5 m, angled	XBTZ9680				2.5 m, angled
Modicon Premium with TSXSCY2160● , 25-way female SUB-D connector, Uni-TE (V1/V2) protocol							
XBTP	RS 485 serial port, 25-way SUB-D	2.5 m	XBTZ918	XBTR	RS 485 serial port, 25-way SUB-D	2.5 m	XBTZ918
Modicon Quantum , 9-way male SUB-D connector, Modbus protocol							
XBTP	RS 232C serial port, 25-way SUB-D	2.5 m	XBTZ9710	XBTR	RS 232C serial port, 25-way SUB-D	2.5 m	XBTZ9710
Advantys STB , HE13 connector (network interface module, NIM), Modbus protocol							
XBTP	RS 232C serial port, 25-way SUB-D	2.5 m	XBTZ988	XBTR	RS 232C serial port, 25-way SUB-D	2.5 m	XBTZ988
Modicon Momentum M1 , RJ45 connector (port 1), Modbus protocol							
XBTP	RS 232C serial port, 25-way SUB-D	2.5 m	XBTZ9711	XBTR	RS 232C serial port, 25-way SUB-D	2.5 m	XBTZ9711
TeSys U starters, ATV 31/61/71 drives, ATS 48 starters , RJ45 connector, Modbus protocol							
XBTP	RS 485 serial port, 25-way SUB-D	2.5 m	XBTZ938	XBTR	RS 485 serial port, 25-way SUB-D	2.5 m	XBTZ938
LT6 P multifunction protection relay , 9-way female SUB-D connector, Modbus protocol							
XBTP	RS 232C serial port, 25-way SUB-D	2.5 m	XBTZ938	XBTR	RS 232C serial port, 25-way SUB-D	2.5 m	XBTZ938

Equivalent product table - Cables for application transfer to PC and printer cable

Old range XBTP				XBTR range			
Type of terminal	Type of link	Length	Reference	Type of terminal	Type of link	Length	Reference
Cables for application transfer to PC							
XBTP	25-way SUB-D/ 9-way SUB-D	2.5 m	XBTZ915	XBTR	25-way SUB-D/ 9-way SUB-D	2.5 m	XBTZ915
	25-way SUB-D/USB	2.5 m	XBTZ915 + adaptor SR2CBL06		25-way SUB-D/ USB	2.5 m	XBTZ915 + adaptor SR2CBL06
Serial printer cable							
XBTP	Printer port, 9-way SUB-D	2.5 m	XBTZ936	XBTR	Printer port, mini-DIN 8	2.5 m	XBTZ926

(1) Mechanical adaptor for mounting XBTR terminal in place of the substituted XBTP terminal.

Compatibility table - Downloadable third-party protocols

PLC brand	Compatibility		Protocol name
	XBTP	XBTR	
Allen-Bradley	■	■	DF1/DH485
GE Fanuc	■	–	SNPX
Omron	■	■ (on RS 232)	Sysmacway
Siemens	■	■	PPI
	■	–	AS511, 3964R, MPI

Equivalent product table - Cables for connection to third-party PLCs

Omron CQM1 & CVM1, Sysmac PLCs

Old range XBTP					XBTR range				
Type of terminal	Type of connector	Serial port	Length	Reference	Type of terminal	Type of connector	Serial port	Length	Reference
Sysmacway protocol									
XBTP	25-way SUB-D/ 9-way SUB-D	RS 232	2.5 m	XBTZ9740	XBTR	25-way SUB-D/ 9-way SUB-D	RS 232C	2.5 m	XBTZ9740

Rockwell Automation, Allen-Bradley PLCs

Old range XBTP					XBTR range				
Type of terminal	Type of connector	Serial port	Length	Reference	Type of terminal	Type of connector	Serial port	Length	Reference
DF1 protocol									
XBTP <i>AP SLC5</i>	25-way SUB-D/ 9-way SUB-D	RS 232C	2.5 m	XBTZ9730	XBTR <i>AP SLC5</i>	25-way SUB-D/ 9-way SUB-D	RS 232C	2.5 m	XBTZ9730
XBTP <i>AP PLC5</i>	25-way SUB-D/ 25-way SUB-D	RS 232C	2.5 m	XBTZ9720	XBTR <i>AP PLC5</i>	25-way SUB-D/ 25-way SUB	RS 232C	2.5 m	XBTZ9720
XBTP <i>AP Micro-logix</i>	25-way SUB-D/ Micro-logix 1000	RS 232C	2.5 m	XBTZ9731	XBTR <i>AP Micro-logix</i>	25-way SUB-D/ Micro-logix 1000	RS 232C	2.5 m	XBTZ9731
DH 485 point-to-point protocol									
XBTP <i>AP Micro-logix</i>	25-way SUB-D/ Micro-logix 1000	RS 232C	2.5 m	XBTZ9732	XBTR <i>AP Micro-logix</i>	25-way SUB-D/ Micro-logix 1000	RS 232C	2.5 m	XBTZ9732
DH 485 multidrop protocol									
XBTP <i>SLC500 with AIC gateway</i>	25-way SUB-D/ 9-way SUB-D	RS 232C	2.5 m	XBTZ9730	XBTR <i>AP SLC5 with AIC gateway</i>	25-way SUB-D/ Micro-logix 1000	RS 232C	2.5 m	XBTZ9732

Siemens, Simatic PLCs

Old range XBTP					XBTR range				
Type of terminal	Type of connector	Serial port	Length	Reference	Type of terminal	Type of connector	Serial port	Length	Reference
PPI (S7) protocol									
XBTP	25-way SUB-D/ 9-way SUB-D	RS 485	2.5 m	XBTZ9721	XBTR	25-way SUB-D/ 9-way SUB-D	RS 485	2.5 m	XBTZ9721

Equivalent product table - Connection to Uni-Telway serial link

Old range XBTP					XBTR range				
Type of terminal	Type of connector	Serial port	Length	Reference	Type of terminal	Type of connector	Serial port	Length	Reference
On subscriber socket TSXSCA62									
XBTP	25-way SUB-D/ 15-way SUB-D	RS 485	1.8 m	XBTZ908	XBTR	25-way SUB-D/ 15-way SUB	RS 485	1.8 m	XBTZ908
On connection box TSXPACC01									
XBTP	25-way SUB-D/ 8-way mini-DIN	RS 485	2.5 m 5 m	XBTZ968 XBTZ9681	XBTR	25-way SUB-D/ 8-way mini-DIN	RS 485	2.5 m 5 m	XBTZ968 XBTZ9681

Equivalent product table - Connection to Modbus serial link

Old range XBTP					XBTR range				
Type of terminal	Type of connector	Serial port	Length	Reference	Type of terminal	Type of connector	Serial port	Length	Reference
On subscriber socket TSXSCA64									
XBTP	25-way SUB-D/ 15-way SUB-D	RS 485/ RS422	1.8 m	XBTZ908	XBTR	25-way SUB-D/ 15-way SUB-D	RS 485/ RS 422	1.8 m	XBTZ908
On 8-port splitter box LU9GC3									
XBTP	25-way SUB-D/RJ45	RS 485	2.5 m	XBTZ938	XBTR	25-way SUB-D/RJ45	RS 485	2.5 m	XBTZ938

Applications Traditional architecture, HMI executed on PC platform or dedicated terminal
Configuration software for HMI applications

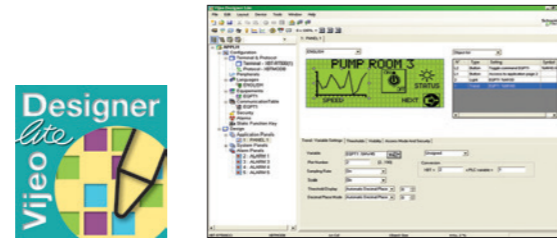

Compatible products	Type	Magelis™ XBTN/R Small panels (1)
	Maximum number of targets	1
	Operating system on terminals	Proprietary Magelis™
Functions	Reading/writing of PLC variables	Yes
	Display of variables	Yes
	Data processing	–
	Sharing of variables between HMI applications	–
	Saving of variables to external database	–
Internationalization		–
Development of graphic applications	Native library of graphic objects	Yes
	Curves and alarms	Yes (2)
	Scripts	–
Communication between HMI application and PLCs		Via I/O drivers: Schneider Electric or third-party protocols (Mitsubishi, Omron, Rockwell Automation, Siemens)
Uploading of applications		Yes
Simulation of HMI applications		Yes
Recipe management		–
Report and barcode printing		–
Screen capture		–
Access security		Linked to user profiles
Interface languages		Screens, online help, and documentation in electronic format available in 7 languages: English, French, German, Italian, Portuguese, Simplified Chinese, and Spanish
OS compatibility		Windows XP Professional, Windows Vista Business (32-bit), Windows 2000 Professional
Software type		Vijeo Designer™ Lite
Pages		For more information please refer to the Vijeo Designer HMI configuration software catalog on our website www.schneider-electric.com .

(1) All Magelis™ XBT and Magelis™ GTO/GTU terminals behave transparently on restoration of power.
(2) Depending on compatible product.

Applications Traditional architecture, HMI executed on PC platform or dedicated terminal
Configuration software for HMI applications

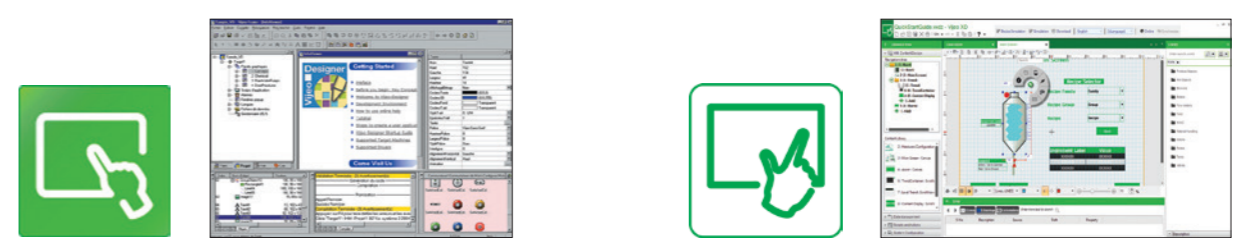

Compatible products	Type	Magelis™ STO/STU Small panels Magelis™ XBTGT/GK/GH/GTO Advanced panels and Magelis™ GTU Universal panels (1) Magelis™ Industrial PCs	Magelis™ STO Color Magelis™ GTO Advanced panels and Magelis™ GTU Universal panels Magelis™ Industrial PCs Windows compatible machines
	Maximum number of targets	32	1
	Operating system on terminals	Proprietary for Magelis™ STO/STU, Magelis™ XBTGT/GK/GH and Magelis™ GTO/GTU	Proprietary for Magelis™ STO Color, Magelis™ GTO/GTU Windows Embedded Standard 7 for Magelis™ Industrial PCs
Functions	Reading/writing of PLC variables	Yes, up to 8,000 internal and external variables	
	Display of variables	Yes	
	Data processing	Yes, using expression editor or Java programming	Yes, using convertor or action editor
	Sharing of variables between HMI applications	Up to 300 variables between 8 terminals, without router PLC Proprietary protocol above TCP/IP	–
	Saving of variables to external database	Yes, with the Intelligent Data Service extension	–
Internationalization		Up to 15 languages supported by 34 Western alphabets, 4 Asian alphabets and 2 Middle Eastern alphabets embedded in the application	Up to 32 languages supported by 34 type of fonts embedded in the application
Development of graphic applications	Native library of graphic objects	Yes	
	Curves and alarms	Yes, with log	
	Scripts	Java	–
Communication between HMI application and PLCs		Via I/O drivers: Schneider Electric or third-party protocols (Mitsubishi, Omron, Rockwell Automation, Siemens)	
Uploading of applications		Yes	–
Simulation of HMI applications		Yes	
Recipe management		Yes, up to 32 groups, 1,024 ingredients for 256 recipes per group, proprietary or CSV format, complete multilingual support for labels and ingredients	
Report and barcode printing		On the fly alarms, log data. Up to 9,999 active alarms, records, or logs Main barcode types supported: UPC-A, UPC-E, JAN/EAN8, JAN/EAN13, ITF, CODE39, CODE93, CODE128, CODABAR (NW-7)	–
Screen capture		Yes, for Magelis™ XBTGT (XBTGT1105 and higher), Magelis™ GTO/GTU, and Magelis™ industrial PCs. JPEG format	Yes, for Magelis™ GTU Open Box and Magelis™ industrial PCs. PNG format
Access security		Linked to user profiles	
Interface languages		Screens, online help, and documentation in electronic format available in 7 languages: English, French, German, Italian, Portuguese, Simplified Chinese, and Spanish	
OS compatibility		Windows XP Professional, Windows 7 Business (32-bit/64-bit)	Windows 7, 8, 8.1, 10 (32-bit/64-bit)
Software type		Vijeo Designer™	Vijeo XD™
Pages		For more information, please refer to the Vijeo Designer HMI configuration software catalog on our website www.schneider-electric.com .	For more information, please refer to the Vijeo XD HMI configuration software catalog on our website www.schneider-electric.com .

Human Machine Interface



Schneider Electric Industries SAS

Head Office
35, rue Joseph Monier
F-92500 Rueil-Malmaison
France

www.schneider-electric.com/hmi

The information provided in this documentation contains general descriptions and/or technical characteristics of the performance of the products contained herein. This documentation is not intended as a substitute for and is not to be used for determining suitability or reliability of these products for specific user applications. It is the duty of any such user or integrator to perform the appropriate and complete risk analysis, evaluation and testing of the products with respect to the relevant specific application or use thereof. Neither Schneider Electric nor any of its affiliates or subsidiaries shall be responsible or liable for misuse of the information contained herein.

Design: Schneider Electric
Photos: Schneider Electric