

# FOTEK

Free power  
Photo sensor

**E3 / M3 series**

自由電源型光電開關



- ◆ Extensive operating voltage
- ◆ Longer sensing distance
- ◆ High compact structure
- ◆ Multi-protection circuit

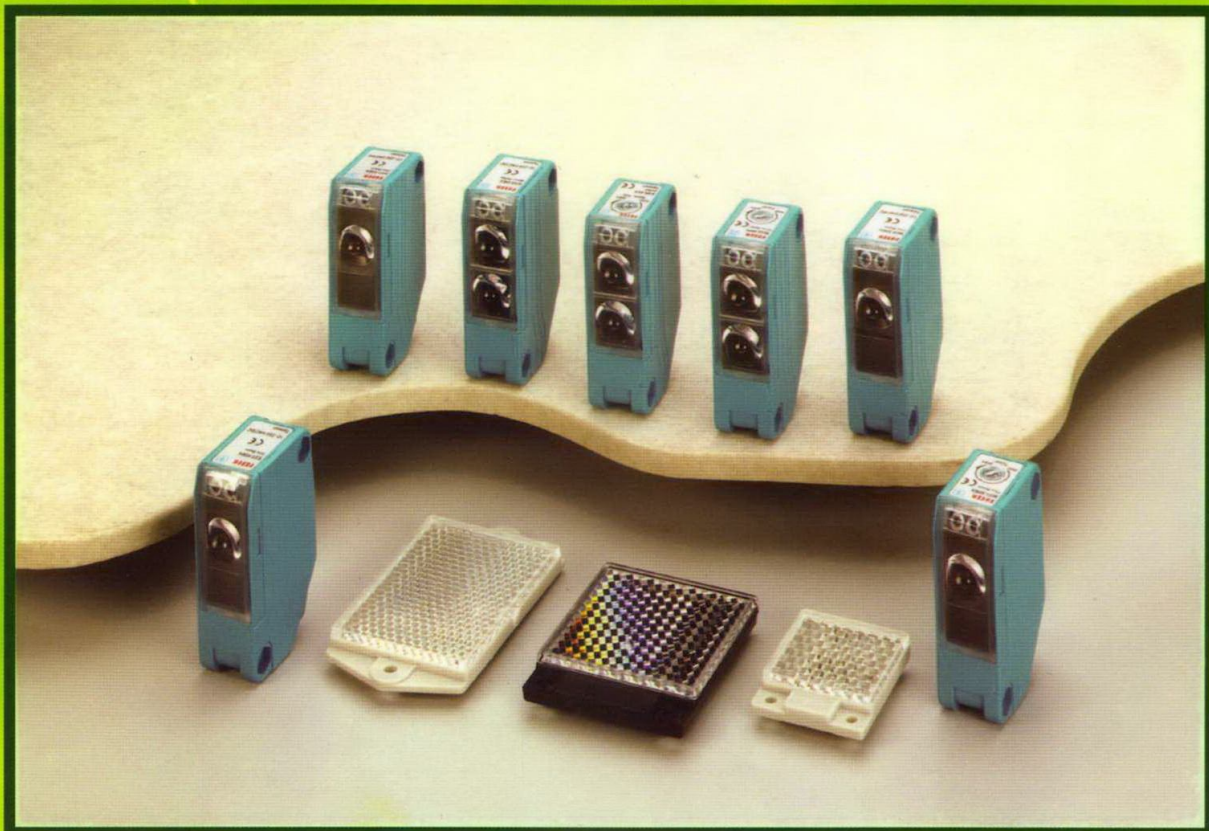

陽明電機股份有限公司  
**FOTEK CONTROL CO., LTD.**

※ **Extensive operating voltage**

– 12 ~ 250 VAC / DC

※ **Longer sensing distance**

– Thru bean type : 30 m  
– Mirror reflex type : 8 m

※ **High compact structure**

– IP-66

※ **Multi-protection circuit**

– Burst test over 2kv

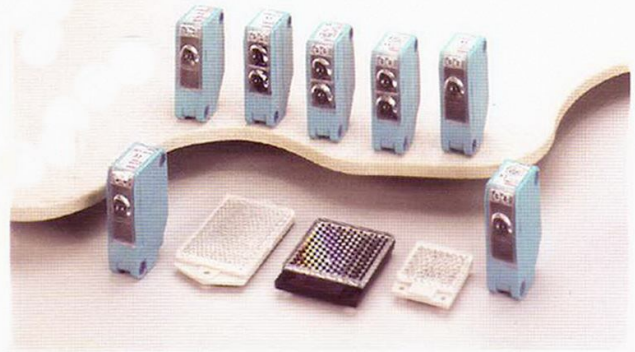

## General Specification / 共同規格

Specification	規格	Data
Operating voltage	工作電壓	20~260VAC / DC
Current consumption	消耗電流	2VA max.
Output method	輸出方式	relay ( 1c )
Contact rated	接點額定電流	1A / 250VAC ; 2A / 30VDC ( Resistance load )
Life of relay	繼電器壽命	Electronic : 10 <sup>6</sup> times ; Mechanic : 10 <sup>9</sup> times
Response time	應答時間	10 ms max.
Illumination	耐外亂光	lamplight < 10,000 Lux ; Sunlight < 30,000 Lux
Connection method	出線方式	5 φ / 6 φ 2m cable ; oil proof
Insulation resistance	絕緣阻抗	100MΩ / 500VDC
Dielectric strength	電介強度	2.5KV / 1 minute min.
EMC standard	EMC標準	ESD : 8 KV air discharge ( level 3 ) / EN-61000-4-2 RF interference : 10V / M / ENV-50140 Burst test : 2KV / EN-61000-4-4
Vibration resistance	耐震動	10 ~ 55Hz / 1.5 mm, 2 hours in XYZ direction
Housing material	外殼材質	Intensive ABS
Protection class	保護等級	IP-66
Operating circumstance	使用環境	- 20°C ~ + 60°C ; 35% ~ 85% RH
Connection diagram	接線圖	

# 自由電源型光電開關 Free Power Photo Sensor



## E3/M3 Series

### ■ Reflex type / 擴散反射型

Type	型式	Standard type		Timer type	
Model	型號	E3R-60X	E3R-60XB	M3R-60X	M3R-60XB
Output status	輸出狀態	NO	NC	NO	NC
Output delay	輸出延遲	Without		Off delay ( 0 ~ 1 sec adjustable )	
Emitter	發射光源	Infrared LED			
Sensing distance	檢測距離	600.0mm			
Hysteresis	復歸應差	20% of sensing distance max.			
Sensible object	最小檢測物	10 § min.			
Sensitivity adjuster	感度調整	270° trimmer			

### ■ Mirror reflex type / 鏡片反射型

Type	型式	Standard type		Timer type	
Model	型號	E3G-8MX	E3G-8MXB	M3G-8MX	M3G-8MXB
Output status	輸出狀態	NO	NC	NO	NC
Output delay	輸出延遲	Without		On delay ( 0 ~ 1sec adjustable )	
Emitter	發射光源	Infrared LED			
Sensing distance 檢測距離	MR-1	8.0 m min.			
	MR-2	4.0 m min.			
	MR-3	12.0 m min.			
Sensible object	最小檢測物	10 § min.			
Sensitivity adjuster	感度調整	non			

### ■ Polarized mirror reflex type / 偏光式鏡片反射型

Type	型式	Standard type		Timer type	
Model	型號	E3G-6MRE	E3G-6MREB	M3G-6MRE	M3G-6MREB
Output status	輸出狀態	NO	NC	NO	NC
Output delay	輸出延遲	Without		On delay ( 0 ~ 1sec adjustable )	
Emitter	發射光源	Red LED			
Sensing distance 檢測距離	MR-1	6.0m min.			
	MR-2	3.0m min.			
	MR-3	8.0m min.			
Sensible object	最小檢測物	10 § min.			
Sensitivity adjuster	感度調整	non			

### ■ Thru beam type / 透過型

Type	Standard type				Timer type	
Model	E3T-10MX	E3T-10MXB	E3T-30MX	E3T-30MXB	M3T-30MX	M3T-30MXB
Output status	NO	NC	NO	NC	NO	NC
Output delay	non		non		On delay ( 0 ~ 1 sec adjustable )	
Sensing distance	12.0 m min.		32.0 m min.		32.0 m min.	
Sensible object	10 § min		20 § min.		20 § min.	
With slot / 加裝光柵 ( 5mmx2mm )						
Sensing distance	5.0m		15.0m		15.0m	
Sensible object	5 § min		10 § min.		10 § min.	
Sensitivity adjuster	non					

Notes: Sensing Distance 50 m, accepted to manufacture.

## ■ Outline dimension / 外型尺寸

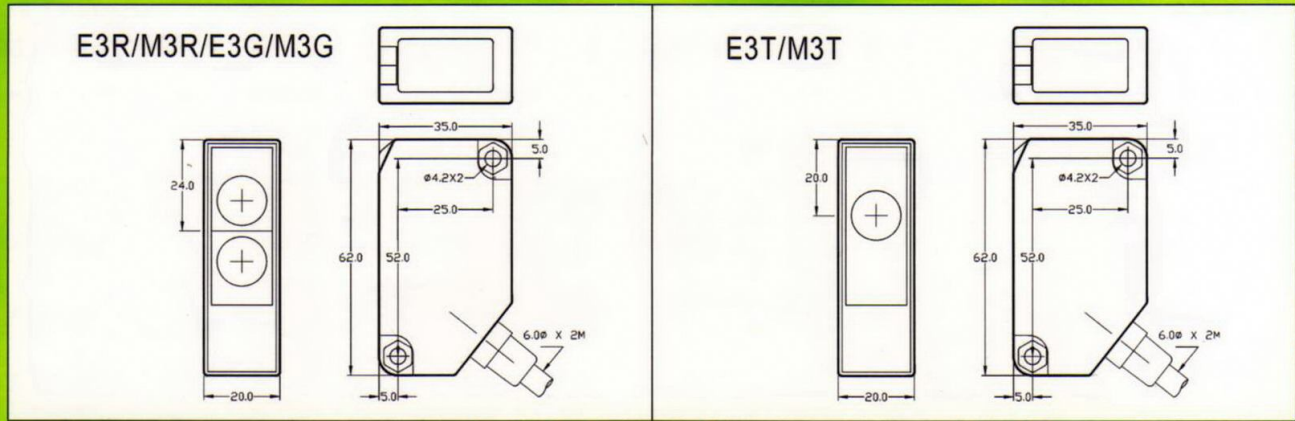

## ■ Fixed bracket / 固定角架

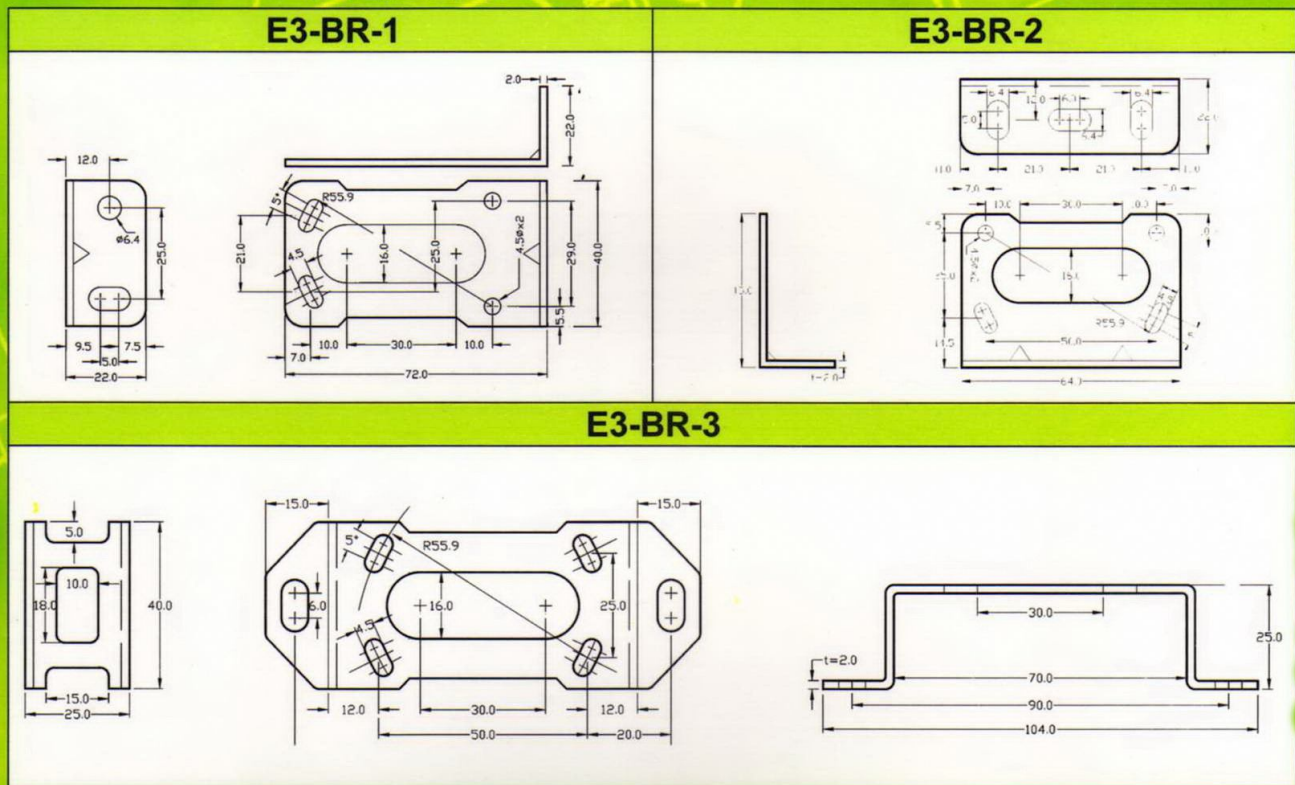

## ■ Mirror / 反射鏡片

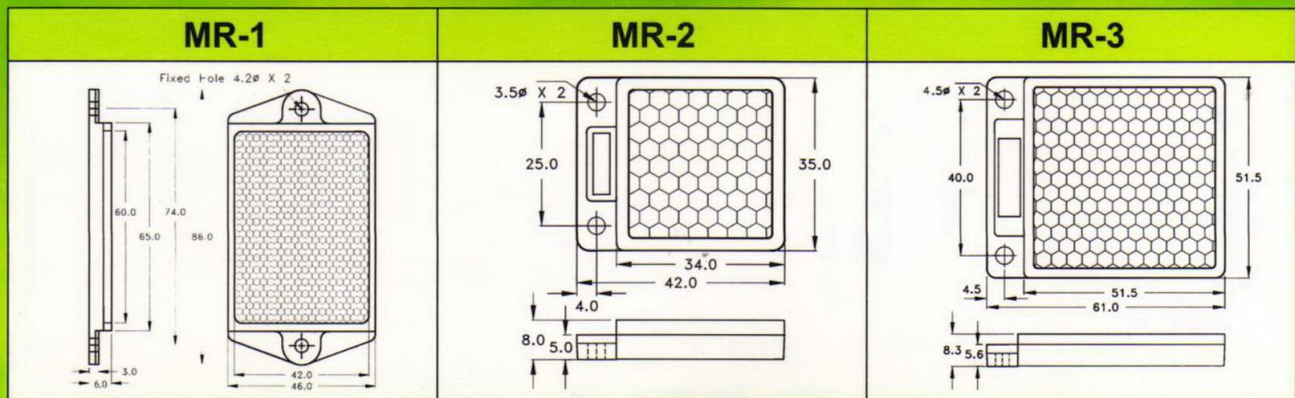

**FOTEK CONTROLS CO., LTD.**

Copy right @FOTEK CONTROLS CO., LTD  
2004/10/29

Specification may be modified without  
notice in advance .