

# W 48 × H 48 mm Analog Timers



## ATN Series PRODUCT MANUAL

For your safety, read and follow the considerations written in the instruction manual, other manuals and Autonics website.

The specifications, dimensions, etc. are subject to change without notice for product improvement. Some models may be discontinued without notice.

### Features

- Wide range of power supply  
: 100 - 240 VAC~ 50 / 60 Hz, 24 - 240 VDC= / 24 VAC~ 50 / 60 Hz, 24 VDC= / 12 VDC=
- Various output operation (6 operation modes)
- Multi time range (16 types of time range)
- Wide control time (0.05 sec to 100 hour)
- Easy setting of time, time range, output operation mode
- Easy to check output status by indicator

### Safety Considerations

- Observe all 'Safety Considerations' for safe and proper operation to avoid hazards.
- ⚠ symbol indicates caution due to special circumstances in which hazards may occur.

**⚠ Warning** Failure to follow instructions may result in serious injury or death.

- 01. Fail-safe device must be installed when using the unit with machinery that may cause serious injury or substantial economic loss. (e.g. nuclear power control, medical equipment, ships, vehicles, railways, aircraft, combustion apparatus, safety equipment, crime/disaster prevention devices, etc.)**  
Failure to follow this instruction may result in personal injury, economic loss or fire.
- 02. Do not use the unit in the place where flammable/explosive/corrosive gas, high humidity, direct sunlight, radiant heat, vibration, impact or salinity may be present.**  
Failure to follow this instruction may result in explosion or fire.
- 03. Install on a device panel to use.**  
Failure to follow this instruction may result in fire or electric shock.
- 04. Do not connect, repair, or inspect the unit while connected to a power source.**  
Failure to follow this instruction may result in fire or electric shock.
- 05. Check 'Connections' before wiring.**  
Failure to follow this instruction may result in fire.
- 06. Do not disassemble or modify the unit.**  
Failure to follow this instruction may result in fire or electric shock.

**⚠ Caution** Failure to follow instructions may result in injury or product damage.

- 01. Use the unit within the rated specifications.**  
Failure to follow this instruction may result in fire or product damage.
- 02. Use a dry cloth to clean the unit, and do not use water or organic solvent.**  
Failure to follow this instruction may result in fire or electric shock.
- 03. Keep the product away from metal chip, dust, and wire residue which flow into the unit.**  
Failure to follow this instruction may result in fire or product damage.

### Cautions during Use

- Follow instructions in 'Cautions during Use'. Otherwise, it may cause unexpected accidents.
- Power supply should be insulated and limited voltage/current or Class2, SELV power supply device.
- When supplying or turning off the power, use a switch or etc. to avoid chattering.
- Install a power switch or circuit breaker in the easily accessible place for supplying or disconnecting the power.
- In order to block peripheral current, use isolation transformer which of secondary part is not grounded to supply power to the external input device.

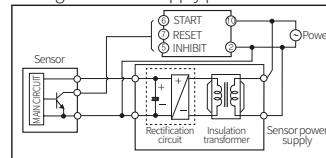

- In order to avoid leakage current flowing, connect resistance and condenser like below. Otherwise, it may cause malfunction.

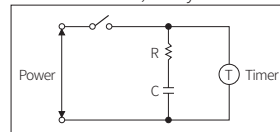

- Do not connect two or more timers with only one input contact or transistor simultaneously.
  - After turning off the power, change the time range, etc.
  - Keep away from high voltage lines or power lines to prevent inductive noise. In case installing power line and input signal line closely, use line filter or varistor at power line and shielded wire at input signal line.
- Do not use near the equipment which generates strong magnetic force or high frequency noise.
- This unit may be used in the following environments.
- Indoors (in the environment condition rated in 'Specifications')
  - Altitude max. 2,000 m
  - Pollution degree 2
  - Installation category II

## Ordering Information

This is only for reference, the actual product does not support all combinations. For selecting the specified model, follow the Autonics website.

**AT** **1** **2** **N** - **3**

### 1 Plug type

8: 8-pin plug  
11: 11-pin plug

### 2 Output

No mark: Time limit DPDT (2c), Instantaneous SPDT (1c) + Time limit SPDT (1c)  
D: Time limit DPDT (2c)  
E: Instantaneous SPDT (1c) + Time limit SPDT (1c)

### 3 Power supply

No mark: 100 - 240 VAC 50 / 60 Hz, 24 - 240 VDC  
1: 12 VDC  
2: 24 VAC 50 / 60 Hz, 24 VDC

## Product Components

- Product (+ bracket)
- Instruction manual

## Sold Separately

- 8-pin controller socket: PG-08, PS-08(N)
- 11-pin controller socket: PG-11, PS-11(N)

## Dimensions

- Unit: mm, For the detailed drawings, follow the Autonics website.

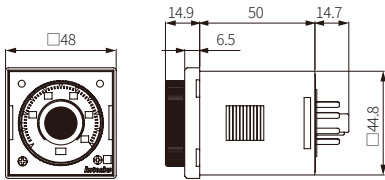

### Bracket

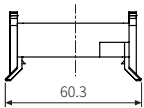
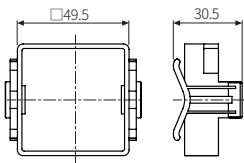

### Panel cut-out

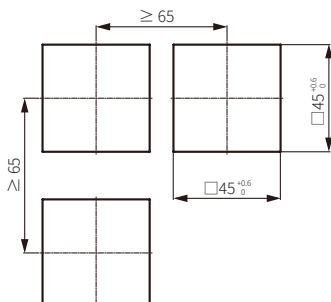

## Unit Descriptions

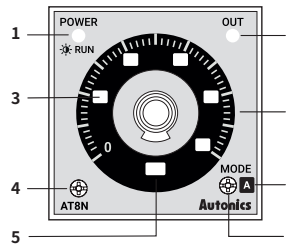

No.	Name
1	Power indicator
2	Time limit output indicator
3	Time range display part
4	Time range setting switch
5	Time unit display part • sec: second, min: minute, hrs: hour, 10h: ×10 hour
6	Output operation mode setting switch
7	Output operation mode display part
8	Dial for the time setting

## Output Operation Mode

For the detailed timing chart for operation output mode, refer to the manual. The output operation mode differs depending on each model.

### AT8N

Display part	Output operation mode
A	Power ON Delay
A1	Power ON Delay1 (One-shot output)
B	Power ON Delay2
F	Flicker (OFF Start)
F1	Flicker1 (ON Start)
I	Interval

### AT11□N

Display part	Output operation mode
A	Signal ON Delay
F	Flicker (OFF Start)
F1	Flicker1 (ON Start)
C	Signal OFF Delay
D	Signal ON/OFF Delay
I	Interval

## Time Range

The unit of time range follows the time unit display part (sec, min, hrs). If the display part is set 10h, the unit of the time range is the hour.

Display	Range	Unit
0.5	0.05 to 0.5	sec / min / hrs
1	0.1 to 1	
5	0.5 to 5	
10	1 to 10	

Display	Range	Unit
0.5	0.5 to 5	10h
1	1 to 10	
5	5 to 50	
10	10 to 100	

## Connections

### Caution

- Refer to the 'specifications' for checking the power supply and control output.
  - The AT11□N model: Be sure to use terminal No. 2 as the common terminal to connect terminals No. 5, 6, and 7.
- Failure to follow this instruction may result in product malfunction.

### AT8N

- Output operation mode: A, F

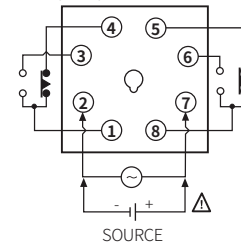

- Output operation mode: A1, B, F1, I

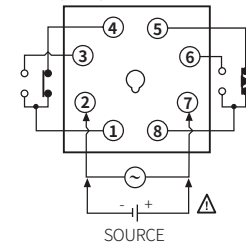

### AT11DN

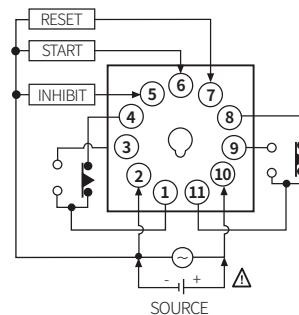

### AT11EN

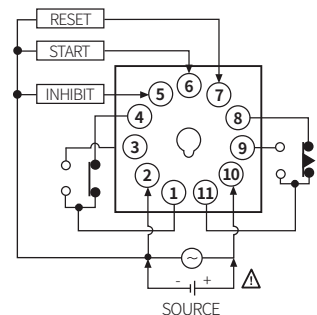

## Specifications

Model	AT8N-□	AT11DN-□	AT11EN-□
<b>Function</b>	Multi Function Timer		
<b>Return time</b>	≤ 100 ms		
<b>Time operation</b>	Power ON Start	Signal ON Start	
<b>Input</b>	-	INHIBIT, START, RESET	
Min. signal width	-	≈ 50 ms	
No-voltage input	-	Short-circuit impedance: ≤ 1 kΩ Short-circuit residual voltage: ≤ 0.5 VDC≐ Open-circuit impedance: ≥ 100 kΩ	
<b>Control output</b>	Relay		
Contact type	Time limit DPDT (2c), Time limit SPDT (1c) + Instantaneous SPDT (1c)	Time limit DPDT (2c)	Time limit SPDT (1c) + Instantaneous SPDT (1c)
Contact capacity	250 VAC~ 5 A, 30 VDC≐ 5 A resistive load	250 VAC~ 5 A, 24 VDC≐ 5 A resistive load	250 VAC~ 5 A, 30 VDC≐ 5 A resistive load
<b>Error</b>	Repeat: ≤ ± 0.2% ± 10 ms SET: ≤ ± 5% ± 50 ms Voltage: ≤ ± 0.5% Temp.: ≤ ± 2%		
<b>Certification</b>	CE, ENEC, VDE, ENEC		
<b>Unit weight (packaged)</b>	≈ 86.71 g (≈ 134.12 g)	≈ 85 g (≈ 132.2 g)	≈ 87.5 g (≈ 134.7 g)
<b>Power supply</b>	100 - 240 VAC~ 50 / 60 Hz, 24 - 240 VDC≐	12 VDC≐	24 VAC~ 50 / 60 Hz, 24 VDC≐
<b>Permissible voltage range</b>	90 to 110 % of rated voltage		
<b>Power consumption</b>	It depends on the model.		
AT8N-□	AC: ≤ 4.3 VA DC: ≤ 2 W	DC: ≤ 1.5 W	AC: ≤ 4.5 VA DC: ≤ 2 W
AT11DN-□	AC: ≤ 3.5 VA DC: ≤ 1.5 W	DC: ≤ 1 W	AC: ≤ 4 VA DC: ≤ 1.5 W
AT11EN-□	AC: ≤ 4.3 VA DC: ≤ 2 W	DC: ≤ 1.5 W	AC: ≤ 4.5 VA DC: ≤ 2 W
<b>Insulation resistive</b>	≥ 100 MΩ (500 VDC≐ megger)		
<b>Dielectric strength</b>	Between the charging part and the case : 3,000 VAC~ at 50 / 60 Hz for 1 min		
<b>Noise immunity</b>	± 2 kV square-wave noise by noise simulator (pulse width 1 μs)	± 500 V square-wave noise by noise simulator (pulse width 1 μs)	
<b>Vibration</b>	0.75 mm double amplitude at frequency of 10 to 55 Hz in each X, Y, Z direction for 1 hour		
<b>Vibration (malfunction)</b>	0.5 mm double amplitude at frequency of 10 to 55 Hz in each X, Y, Z direction for 10 min		
<b>Shock</b>	300 m/s <sup>2</sup> (≈ 30 G) in each X, Y, Z direction for 3 times		
<b>Shock (malfunction)</b>	100 m/s <sup>2</sup> (≈ 30 G) in each X, Y, Z direction for 3 times		
<b>Relay life cycle</b>	Mechanical: ≥ 10,000,000 operations Electrical: ≥ 100,000 operations (250 VAC~ 5 A resistive load)		
<b>Ambient temperature</b>	-10 to 55 °C, storage: -25 to 65 °C (no freezing or condensation)		
<b>Ambient humidity</b>	35 to 85%RH, storage: 35 to 85%RH (no freezing or condensation)		

## ■ Contact capacity

- IEC (EN60947-5-1)

Model	AT8N-□		AT11DN-□		AT11EN-□	
<b>Rated current</b>	5 A		5 A		5 A	
<b>Rated voltage</b>	30 V	250 V	24 V	250 V	30 V	250 V
<b>AC Resistive load (AC-12)</b>	-	5 A	-	5 A	-	5 A
<b>DC Resistive load (DC-12)</b>	5 A	-	5 A	-	5 A	-

## Output Operation Mode

### ■ AT8N

- t : setting time (t > t-a), Rt : return time (Rt1 > Rt2)

A

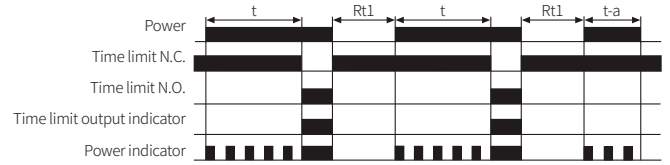

A1

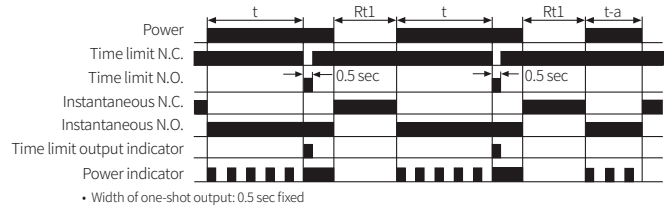

B

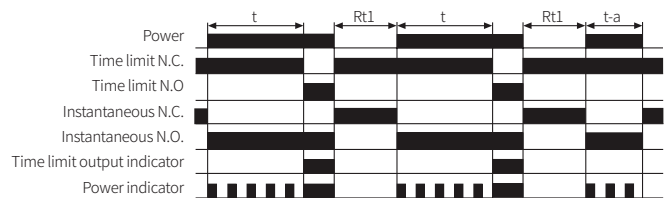

F

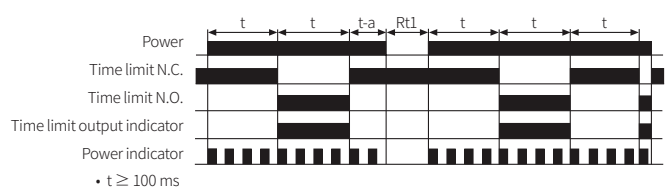

F1

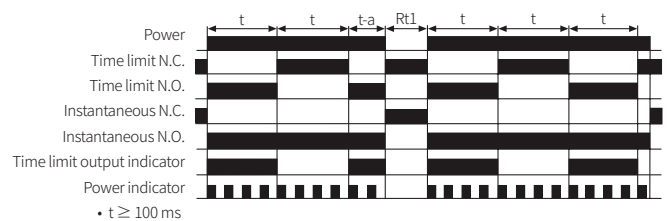

I

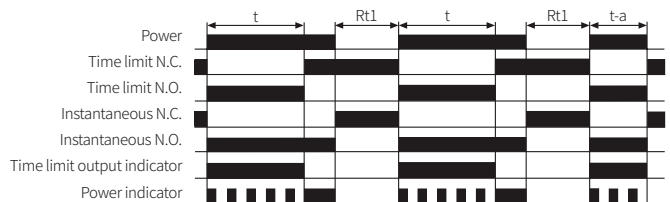

## ■ AT11□N

RESET: Turn OFF the power or short the RESET terminal.

If the INHIBIT terminal is short-circuited during the time limit operation, the time progress will stop.

- t: setting time ( $t = t_1 + t_2$ ,  $t > t-a$ )

**A**

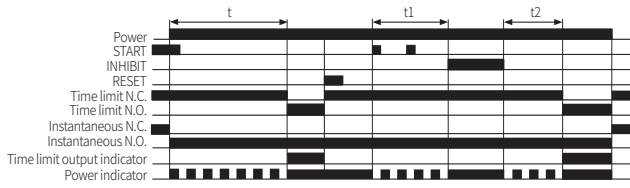

**F**

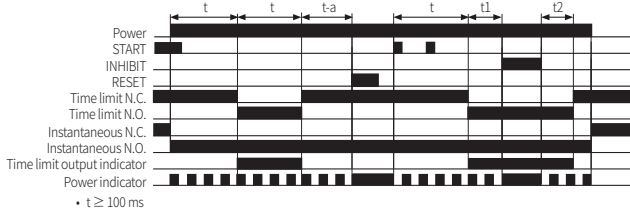

**F1**

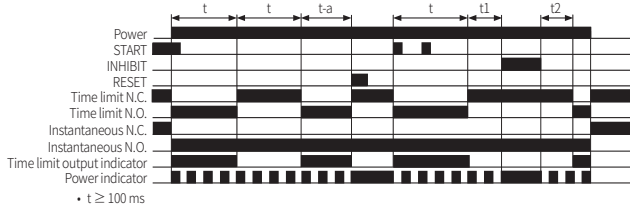

**C**

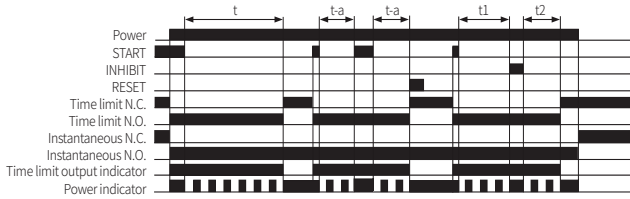

**D**

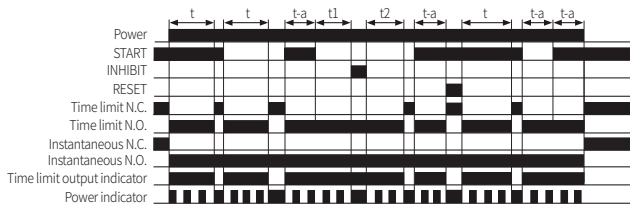

**I**

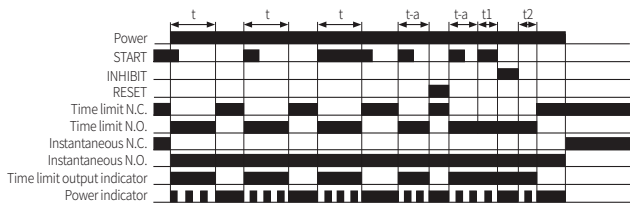

## Sold Separately: 8-pin Controller Socket

- For detailed information, refer to the 'PG Series, PS Series' manual.

Appearance	Pins	Rated Voltage	Rated current	Feature	Model
	8-pin	250 VAC~	7 A (resistance load)	Controller sockets	PG-08
	8-pin	250 VAC~	7 A (resistance load)	Controller sockets (DIN Rail / Panel)	PS-08(N)

## Sold Separately: 11-pin Controller Socket

- For detailed information, refer to the 'PG Series, PS Series' manual.

Appearance	Pins	Rated Voltage	Rated current	Feature	Model
	11-pin	250 VAC~	7 A (resistance load)	Controller socket	PG-11
	11-pin	250 VAC~	7 A (resistance load)	Controller socket (DIN Rail / Panel)	PS-11(N)