

# 1-Channel Digital Temperature Indicators



## KN-2000W Series PRODUCT MANUAL

**For your safety, read and follow the considerations written in the instruction manual, other manuals and Autonics website.**

The specifications, dimensions, etc are subject to change without notice for product improvement. Some models may be discontinued without notice.

### Features

- High accuracy with 16 bit ADC ( $\pm 0.2\%$  F.S.)
- Max. display range: -19999 to 19999
- Multi-input
  - Thermometer 12 types
  - RTD 5 types
  - Analog: Current 2 types/voltage 6 types
- Auto display color change function
  - Selectable indicator colors when error occurs or alarm operates
- Various output options
  - Alarm output: 2 points/4 points
  - 4-20 mA transmission output (isolated), RS485 Communication output
- Various functions
  - High/Low peak input monitoring
  - Alarm output (upper/lower, sensor break)
  - Transmission output/display scale
  - Digital input (DI), etc.
- Built-in power supply for sensor/transmitter (24 VDC)

### Safety Considerations

- Observe all 'Safety Considerations' for safe and proper operation to avoid hazards.
- **⚠** symbol indicates caution due to special circumstances in which hazards may occur.

**⚠ Warning** Failure to follow instructions may result in serious injury or death

- 01. Fail-safe device must be installed when using the unit with machinery that may cause serious injury or substantial economic loss. (e.g. nuclear power control, medical equipment, ships, vehicles, railways, aircraft, combustion apparatus, safety equipment, crime/disaster prevention devices, etc.)**  
Failure to follow this instruction may result in personal injury, economic loss or fire.
- 02. Do not use or store the unit in the place where flammable/explosive/corrosive gas, high humidity, direct sunlight, radiant heat, vibration, impact or salinity may be present.**  
Failure to follow this instruction may result in explosion or fire.
- 03. Install on a device panel to use.**  
Failure to follow this instruction may result in fire or electric shock.
- 04. Do not connect, repair, or inspect the unit while connected to a power source.**  
Failure to follow this instruction may result in fire or electric shock.
- 05. Check 'Connections' before wiring.**  
Failure to follow this instruction may result in fire.
- 06. Do not disassemble or modify the unit.**  
Failure to follow this instruction may result in fire or electric shock.

**⚠ Caution** Failure to follow instructions may result in injury or product damage

- 01. Use the unit within the rated specifications.**  
Failure to follow this instruction may result in fire or product damage
- 02. Use a dry cloth to clean the unit, and do not use water or organic solvent.**  
Failure to follow this instruction may result in fire or electric shock.
- 03. Keep the product away from metal chip, dust, and wire residue which flow into the unit.**  
Failure to follow this instruction may result in fire or product damage.
- 04. Check the polarity of the measurement input before wiring.**  
Failure to follow this instruction may result in explosion or fire.

### Cautions during Use

- Follow instructions in 'Cautions during Use'. Otherwise, it may cause unexpected accidents.
- For connecting the power, use the crimp terminal (M3.5, max. 7.2 mm)
- 24 VDC power supply should be insulated and limited voltage/current or Class 2, SELV power supply device.
- Keep away from high voltage lines or power lines to prevent inductive noise. Do not use near the equipment which generates strong magnetic force or high frequency noise.
- Install a power switch or circuit breaker in the easily accessible place for supplying or disconnecting the power.
- Use twisted pair wire for communication line.
- This unit may be used in the following environments.
  - Indoors (in the environment condition rated in 'Specifications')
  - Altitude Max. 2,000 m
  - Pollution degree 2
  - Installation category II

## Ordering Information

This is only for reference, the actual product does not support all combinations. For selecting the specified model, follow the Autonics website.

**K N - 2 ① ② ③ W**

### ① Alarm output

0: No (Option output: Transmission is not available)

2: 2 alarm  
4: 2 alarm

### ② Option Output

0: No

1: PV transmission  
4: Communication  
5: PV transmission + Communication

### ③ Power supply

0: 100-240 VAC 50/60 Hz  
1: 24 VDC

## Product Components

- Product
- Instruction manual
- Bracket ×2

## Software

Download the installation file and the manuals from the Autonics website.

### ■ DAQMaster

DAQMaster is comprehensive device management program. It is available for parameter setting, monitoring.

## Specifications

Series	KN-2000W Series	
	AC voltage	DC voltage
Power supply	100 - 240 VAC ~ 50/60 Hz	24 VDC=
Permissible voltage range	90 to 110 % of rated voltage	
Power consumption	≤ 8 VA	≤ 3 W
Sampling period	• Thermocouple, RTD: 250 ms • Analog: 100 ms	
Input specification	Refer to 'Input Type and Using Range'.	
Digital input	Contact	• ON: ≤ 2 kΩ • OFF: ≥ 90 kΩ
	Non contact	• Residual voltage: ≤ 1.0 V • Leakage current: ≤ 0.03 mA
	Outflow current	≈ 0.2 mA
Option output	Alarm	• 2 point relay: 250 VAC ~ 3 A 1c • 4 point relay: 250 VAC ~ 1 A 1a
	PV Transmission RS485 comm.	ISOLATED DC 4-20 mA (Load resistance: ≤ 600 Ω) Modbus RTU
Display type	7 Segment (Red, Green, Yellow), LED type	
Alarm output Hysteresis	1 to 999 digit	
Relay life cycle	Mechanical	• 2 point: ≥ 10,000,000 operations • 4 point: ≥ 20,000,000 operations
	Electrical	• 2 point: ≥ 100,000 operations (Load resistance: 250 VAC ~ 3 A) • 4 point: ≥ 500,000 operations (Load resistance: 250 VAC ~ 1 A)
Dielectric strength	Between the charging part and the case: 2,000 VAC ~ 50/60 Hz for 1 min	
Vibration	0.75 mm amplitude at frequency of 5 to 55 Hz in each X, Y, Z direction for 2 hours	
Insulation resistance	≥ 100 MΩ (500 VDC= megger)	
Noise immunity	±2 kV square shaped noise (pulse width 1 μs) by noise simulator	
Memory retention	≈ 10 years (non-volatile semiconductor memory type)	
Ambient temperature	-10 to 50 °C, storage: -20 to 60 °C (no freezing or condensation)	
Ambient humidity	35 to 85%RH, storage: 35 to 85%RH (no freezing or condensation)	
Certification	CE UK ENEC	
Unit weight (packaged)	≈ 200 g (≈ 332 g)	

## Communication Interface

### ■ RS485

Comm. protocol	Modbus 1.1 RTU
Maximum connection	32 units
Synchronous method	Asynchronous
Comm. method	Two-wire half duplex
Comm. effective range	≤ 1,200 m (≤ 700 m recommended)
Comm. speed	1,200 / 2,400 / 4,800 / 9,600 (default) / 19,200 bps (parameter)
Data bit	8 bit (fixed)
Parity bit	None (fixed)
Stop bit	1 bit (fixed)

## Input Type and Using Range

Input type	Display	Using range (°C)	Using range (°F)	
Thermo-couple	K (CA)	ℓ ℓ - ℓ	-200.0 to 1350.0	-328 to 2462
	J (IC)	ℓ ℓ - ℓ	-200.0 to 800.0	-328.0 to 1472.0
	E (CR)	ℓ ℓ - ℓ	-200.0 to 800.0	-328.0 to 1472.0
	T (CC)	ℓ ℓ - ℓ	-200.0 to 400.0	-328.0 to 752.0
	R (PR)	ℓ ℓ - ℓ	0.0 to 1750.0	32 to 3182
	B (PR)*	ℓ ℓ - ℓ	400.0 to 1800.0	752 to 3272
	S (PR)*	ℓ ℓ - ℓ	0.0 to 1750.0	32 to 3182
	N (NN)*	ℓ ℓ - ℓ	-200.0 to 1300.0	-328 to 2372
	C (W5)*	ℓ ℓ - ℓ	0 to 2300	32 to 4172
	L (IC)*	ℓ ℓ - ℓ	-200.0 to 900.0	-328.0 to 1652.0
	U (CC)*	ℓ ℓ - ℓ	-200.0 to 400.0	-328.0 to 752.0
	Platinel II*	ℓ ℓ - ℓ	0.0 to 1390.0	32 to 2534
RTD	Cu50Ω*	ℓ ℓ ℓ ℓ	-200.0 to 200.0	-328.0 to 392.0
	Cu100Ω*	ℓ ℓ ℓ ℓ	-200.0 to 200.0	-328.0 to 392.0
	JPt100Ω	ℓ ℓ ℓ ℓ	-200.0 to 600.0	-328.0 to 1112.0
	DPt50Ω	ℓ ℓ ℓ ℓ	-200.0 to 600.0	-328.0 to 1112.0
	DPt100Ω	ℓ ℓ ℓ ℓ	-200.0 to 850.0	-328.0 to 1530.0
Analog	Current	0.00 - 20.00mA	ℓ ℓ ℓ ℓ	-19999 to 19999 (Display range is variable according to decimal point position.)
		4.00 - 20.00mA	ℓ ℓ ℓ ℓ	
	Voltage	-50.00 - 50.00mV	ℓ ℓ ℓ ℓ	
		-200.0 - 200.0mV	ℓ ℓ ℓ ℓ	
		1.0000 - 1.0000V	ℓ - ℓ ℓ	
		-1.000 - 10.000V	ℓ - ℓ ℓ	

\* Above input types which have the \* mark are not displayed. To display the above input types, supply the power with pressing the [M] key.

### ■ Display accuracy

Input type	Using temperature	Display accuracy
Thermocouple RTD	At room temperature (25 °C ± 5 °C)	PV ± 0.2% F.S. ± 1 digit • Thermocouple below -100 °C: (PV ± 0.4% F.S.) ± 1 digit
	Out of room temperature range	PV ± 0.3% F.S. ± 1 digit

\* In case of TC-T, TC-U, ±2.0 °C will be added to the degree standard.

## Unit Descriptions

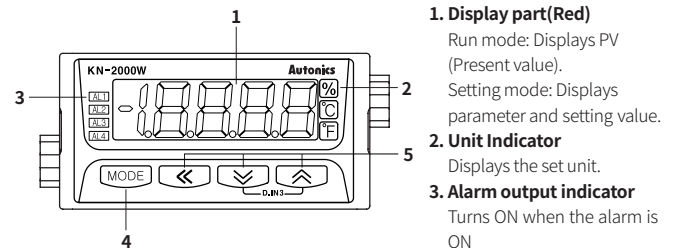

### 1. Display part (Red)

Run mode: Displays PV (Present value).  
Setting mode: Displays parameter and setting value.

### 2. Unit Indicator

Displays the set unit.

### 3. Alarm output indicator

Turns ON when the alarm is ON

### 4. [MODE] key

Used to enter parameter set mode, move to parameters, save SV and return to RUN mode.

### 5. [Left], [Right], [Down] key

Used to enter and change parameter setting value.

### 6. Selection switch for input specification

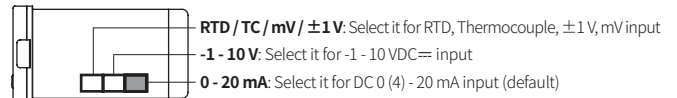

**RTD / TC / mV / ±1 V:** Select it for RTD, Thermocouple, ±1 V, mV input

**-1 - 10 V:** Select it for -1 - 10 VDC= input

**0 - 20 mA:** Select it for DC 0 (4) - 20 mA input (default)

\* The setting of input type selection switch and the setting value of input type parameter should be same and it can display the proper measurement value.

## Dimensions

• Unit: mm, For the detailed drawings, follow the Autonics website.

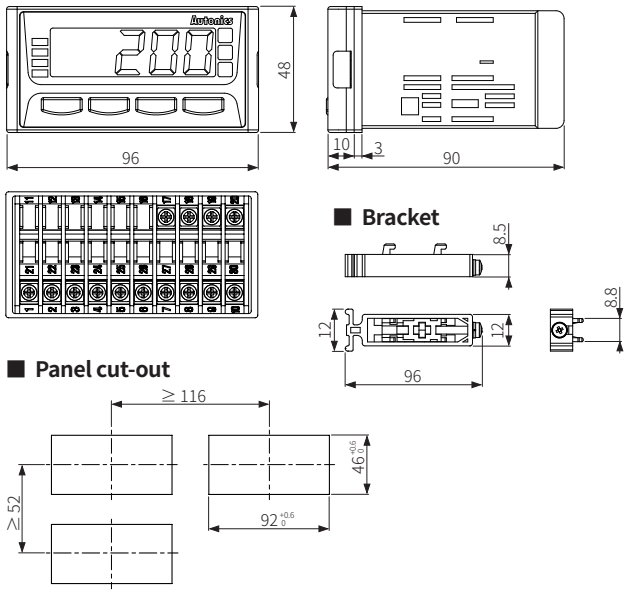

## Connections

### ■ KN-20□□W

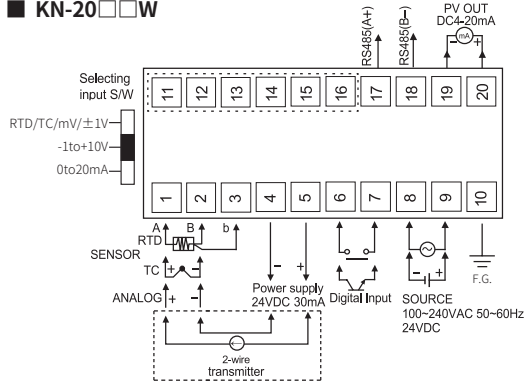

### ■ KN-22□□W

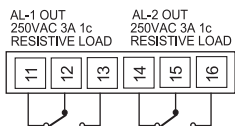

### ■ KN-24□□W

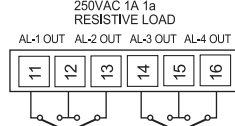

## Errors

Display	Description	Troubleshooting
<i>bUrn</i>	Flashes when input sensor is disconnected or sensor is not connected.	Check input sensor status.
<i>HHHH</i>	Flashes when PV is higher than input range. <sup>(1)</sup>	When input is within the rated input range, this display disappears.
<i>LLLL</i>	Flashes when PV is lower than input range. <sup>(1)</sup>	When input is within the rated input range, this display disappears.
<i>Errr</i>	Flashes when there is an error of setting value	Check the setting condition and reset.
<i>Err l</i>	Flashes when parameter and selection switch setting for input specification are inconsistent	Check input specification.

(1) Be careful that when *HHHH* / *LLLL* error occurs, the control output may occur by recognizing the maximum or minimum input depending on the control type.

## Mode Setting

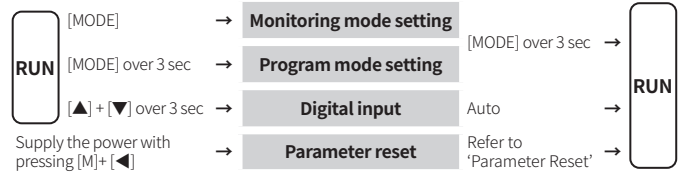

## Parameter Reset

- When supply the power with press [MODE]+ [◀] keys, CLR turns ON.
- Press [MODE] key to parameter reset mode.
- Change the setting value as YES by pressing the [▲], [▼] keys.
- Press the [MODE] key to reset all parameter values as default and to return to run mode.

## Parameter Setting

- Some parameters are activated/deactivated depending on the model or setting of other parameters. Refer to the descriptions of each item.
- [MODE] key: Move to next item after saving / Return to RUN mode after saving (≥ 3 sec)
- [◀] key: Select parameter / Move digits
- [▲], [▼] key: Select parameter / Change setting value
- Return to the upper level without saving when there is no key input for more than 30 seconds.

### ■ Monitoring mode

Parameter	Display	Default	Setting range	Condition
1-1 AL1 alarm temperature	<i>AL 1</i>	<i>099.9</i>	[Alarm output model] Within input range Analog Input: $L-SC \leq AL \leq H-SC$	2-12/14/16/18 AL-1/2/3/4 alarm operation: AT1, AT2
1-2 AL2 alarm temperature	<i>AL 2</i>	<i>099.9</i> (4 alarm model) <i>000.1</i> (2 alarm model)		
1-3 AL3 alarm temperature	<i>AL 3</i>	<i>000.1</i>		
1-4 AL4 alarm temperature	<i>AL 4</i>	<i>000.1</i>		
1-5 High peak display	<i>HPEP</i>	<i>----</i>	Check only (not available to set) Displays high/low peak (Max./Min. input) value • Initial high/low peak is saved after 2 sec from supplying the power.	
1-6 Low peak display	<i>LPEP</i>	<i>----</i>	• Value reset: [▲]+[▼] key over 3 sec in 1-5/6 High/Low peak display parameter	

## Program mode

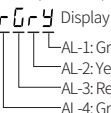
Parameter	Display	Default	Setting range	Condition
2-1 Input specification	<i>i n - P</i>	<i>R n R 2</i>	Refer to 'Input Type and Using Range'.	-
2-2 Temperature unit	<i>U n i t</i>	<i>°C</i>	°C, °F	2-1 Input specification: Thermocouple, RTD
2-3 Display unit	<i>d U n t</i>	<i>°C</i>	%, OFF, °C, °F	
2-4 Low limit Input	<i>L - r G</i>	<i>0 4 0 0</i>	Within input range, L-RG + 20% of F.S. ≤ H-RG	2-1 Input specification: Analog
2-5 High limit Input	<i>H - r G</i>	<i>2 0 0 0</i>		
2-6 Decimal point	<i>d P</i>	<i>0 0</i>	0.0, 0.00, 0.000, 0	
2-7 Low limit scale	<i>L - 5 C</i>	<i>0 0 0 0</i>	-19,999 to 19,999	
2-8 High limit scale	<i>H - 5 C</i>	<i>1 0 0 0</i>	-19,999 to 19,999	
2-9 4 mA output scale	<i>L o U t</i>	<i>0 0 0 0</i>	[PV transmission output model] • Input: Thermocouple, RTD: Within input range • Input: Analog L-SC ≤ L.OUT + 10% of F.S. ≤ H.OUT ≤ H-SC	
2-10 20 mA output scale	<i>H o U t</i>	<i>1 0 0 0</i>		
2-11 Input and transmission output extension <sup>(1)</sup>	<i>E x t 0</i>	<i>5 P</i>	[PV transmission output model] Setting value Input range Transmission output range 0P no extension 4 - 20 mA 5P ±5% extension 3.2 - 20.8 mA 10P ±10% extension 2.4 - 21.6 mA	2-1 Input specification: Analog
2-12 AL1 alarm operation	<i>AL - 1</i>	<i>AL 1 R</i> <input type="checkbox"/> <input type="checkbox"/> <input type="checkbox"/> <input type="checkbox"/>	[Alarm output model] <input type="checkbox"/> <input type="checkbox"/> AT0: Off AT1: Absolute high limit alarm AT2: Absolute low limit alarm SBA: Sensor break alarm	-
2-13 AL1 alarm option	<i>AL - 1</i>	<input type="checkbox"/> <input type="checkbox"/> <input type="checkbox"/> <input type="checkbox"/>	A: Standard alarm B: Alarm latch C: Standby D: Alarm latch and sequence • Enter to option setting: Press [◀] key in 2-15 AL-1 alarm operation.	-
2-14 AL2 alarm operation	<i>AL - 2</i>	<i>AL 1 R</i> (4 alarm model)	[Alarm output model] Same as 2-12/13 AL1 alarm operation/option	-
2-15 AL2 alarm option	<i>AL - 2</i>	<i>AL 2 R</i> (2 alarm model)		-
2-16 AL3 alarm operation	<i>AL - 3</i>	<i>AL 2 R</i>		-
2-17 AL3 alarm option	<i>AL - 3</i>	<i>AL 2 R</i>	[4 alarm output model] Same as 2-12/13 AL1 alarm operation/option	-
2-18 AL4 alarm operation	<i>AL - 4</i>	<i>AL 2 R</i>		-
2-19 AL4 alarm option	<i>AL - 4</i>	<i>AL 2 R</i>		-
2-20 Alarm output hysteresis	<i>A - H Y</i>	<i>0 0 1</i>	001 to 999	2-12/14/16/18 AL-1/2/3/4 alarm operation: AT1, AT2
2-21 Input special function	<i>i n S F</i>	<i>L i n</i>	LIN: Linear, ROOT: Root, SQAR: Square, TUF: Two unit function	-
2-22 Input correction	<i>i n - b</i>	<i>0 0 0 0</i>	-999 to 999	-
2-23 Input digital filter	<i>n A u F</i>	<i>0 4</i>	01 (OFF) to 16	-
2-24 Digital input terminal <sup>(3)</sup>	<i>d i - t</i>	<i>H o L d</i>	HOLD <sup>(4)</sup> : Hold, ZERO: Zero-point adjustment, AL.RE*: Alarm reset *[Alarm output model]	-
2-25 Digital input key <sup>(3)</sup>	<i>d i - k</i>	<i>H o L d</i>		-
2-26 Display color	<i>C L o r</i>	<i>r E d</i>	Setting value Display part Color RED Red Red GRN Green Green YELO Yellow Yellow R-G Red Green G-R Green Red	-
2-27 Alarm display color <sup>(2)</sup>	<i>C - AL</i>	<i>r r r r</i>	[Alarm output model] Select each digit separately. R: Red, G: Green, Y: Yellow <i>r r r r</i> Display color when alarm is ON 	-
2-28 Sensor break alarm output	<i>b U r n</i>	<i>o n</i>	[Transmission output model] OFF: 4 mA - 5%, ON: 20 mA + 5%	-
2-29 Comm. address	<i>A d r r</i>	<i>0 1</i>	[Communication output model] 01to99	-
2-30 Comm. speed	<i>b A U d</i>	<i>9 6 B</i>	[Communication output model] 1.2K: 1200, 2.4K: 2400, 4.8K: 4800, 9.6K: 9600, 19.2K: 19200 bps	-
2-31 Comm. write	<i>C o n Y</i>	<i>E n R</i>	[Communication output model] ENA: Enable, DISA: Disable	-
2-32 Lock	<i>L o C k</i>	<i>o F F</i>	OFF LOC1: Program mode lock (check only) Monitoring mode unlock LOC2: Checking and setting program mode lock Monitoring mode setting lock (check only)	-

- 01) Extension is not allowed below 0 mA and 0 V. ±1 V and 10 V Inputs cannot be set to 10P.  
02) When alarm is cleared, or two alarms operate at the same time, the latest alarm's color is applied.  
When error occurs during alarm, the set color of 'Display color' parameter is applied.  
03) When changing functions, change after releasing the signal being input to the terminal.  
04) The hold function is maintained even when a temperature error occurs.

## Communication Parameter Setting

### Read Input Status (Func: 2, R/W: R)

Address	Parameter	Output range	Condition
100001 (0000)	AL1 indicator	0: OFF, 1: ON	
100002 (0001)	AL2 indicator		
100003 (0002)	AL3 indicator		
100004 (0003)	AL4 indicator		
100005 (0004)	°F indicator		
100006 (0005)	°C indicator		
100007 (0006)	% indicator		

### Read Input Register (Func: 4, R/W: R)

Address	Parameter	Output range	Condition
300001 (0000)	Present value	-19999 to 19999	-
300002 (0001)	Input specification	Refer to 'Input specification parameter setting/output value'	-
300003 (0002)	Decimal point	0004H: .0000, 0003H: 0.000, 0002H: 0.00, 0001H: 0.0, 0000H: 0	2-1 Input specification: Analog
300004 (0003)	PWM OUT	0 to 20000	-
300005 (0004)	X (MSB)	-	-
	% indicator	0: OFF, 1: ON	
	°C indicator		
	°F indicator		
	AL4 indicator		
	AL3 indicator		
	AL2 indicator		
AL1 indicator (LSB)			

### Program mode setting group (Func: 03/06/16, R/W: R/W)

Address	Parameter	Display	Setting range	Condition
400001 (0000)	Input specification	<i>i n - P</i>	Refer to 'Input specification parameter setting/output value'	Same as each parameter setting condition
400002 (0001)	Temperature unit	<i>U n i t</i>	0: °C, 1: °F	
400003 (0002)	Display unit	<i>d U n t</i>	0: °C, 1: °F, 2: %, 3: OFF	
400004 (0003)	High limit Input	<i>H - r G</i>	Same as parameter setting range	
400005 (0004)	Low limit Input	<i>L - r G</i>	Same as parameter setting range	
400006 (0005)	High limit scale	<i>H - 5 C</i>	Same as parameter setting range	
400007 (0006)	Low limit scale	<i>L - 5 C</i>	Same as parameter setting range	
400008 (0007)	Input correction	<i>i n - b</i>	Same as parameter setting range	
400009 (0008)	Input digital filter	<i>n A u F</i>	Same as parameter setting range	
400010 (0009)	AL1 alarm operation	<i>AL - 1</i>	1: Absolute high limit alarm 2: Absolute low limit alarm 3: Sensor break alarm 4: No alarm	
400011 (000A)	AL2 alarm operation	<i>AL - 2</i>		
400012 (000B)	AL3 alarm operation	<i>AL - 3</i>		
400013 (000C)	AL4 alarm operation	<i>AL - 4</i>		
400014 (000D)	AL1 alarm option	<i>AL - 1</i>	10: Standard alarm, 11: Alarm latch, 12: Standby sequence, 13: Alarm latch and standby sequence, 14: No alarm (not settable)	
400015 (000E)	AL2 alarm option	<i>AL - 2</i>		
400016 (000F)	AL3 alarm option	<i>AL - 3</i>		
400017 (0010)	AL4 alarm option	<i>AL - 4</i>		
400018 (0011)	Alarm output hysteresis	<i>A - H Y</i>	Same as parameter setting range	
400019 (0012)	20 mA output scale	<i>H o U t</i>	Same as parameter setting range	
400020 (0013)	4 mA output scale	<i>L o U t</i>	Same as parameter setting range	
400021 (0014)	Decimal point	<i>d P</i>	0004H: .0000, 0003H: 0.000, 0002H: 0.00, 0001H: 0.0, 0000H: 0	
400022 (0015)	Input and transmission output extension	<i>E x t 0</i>	0: 0%, 1: 5%, 2: 10%	
400023 (0016)	Digital input terminal	<i>d i - t</i>	0: Alarm reset, 1: Hold, 2: Zero-point adjustment	
400024 (0017)	Digital input key	<i>d i - k</i>		
400025 (0018)	Input special function	<i>i n S F</i>	0: Linear, 1: Root, 2: Square, 3: Two Unit Function	
400026 (0019)	Sensor break alarm output	<i>b U r n</i>	0: ON, 1: OFF	
400027 (001A)	Lock	<i>L o C k</i>	0: OFF, 1: LOCK1, 2: LOCK2	
400028 (001B)	Display color	<i>C L o r</i>	0: Red, 1: Green, 2: Yellow, 3: Red-Green, 4: Green-Red	
400029 (001C)	AL1 display color	<i>C - AL</i>	0: Red, 1: Green, 2: Yellow	
400030 (001D)	AL2 display color			
400031 (001E)	AL3 display color			
400032 (001F)	AL4 display color			
400033 (0020)	Comm. address	<i>A d r r</i>	Same as parameter setting range	
400034 (0021)	Comm. speed	<i>b A U d</i>	0: 19200, 1: 9600, 2: 4800, 3: 2400, 4: 1200	
400035 (0022)	Comm. write	<i>C o n Y</i>	0: Disable, 1: Enable	

• Func : Read Holding Register/Preset Single Register/Preset Multiple Register

### Monitoring mode setting group (Func: 03/06/16, R/W: R/W)

Address	Parameter	Display	Setting range	Condition
400051 (0032)	AL1 alarm temperature	AL 1	Same as parameter setting range	Same as each parameter setting condition
400052 (0033)	AL2 alarm temperature	AL 2		
400053 (0034)	AL3 alarm temperature	AL 3		
400054 (0035)	AL4 alarm temperature	AL 4		
400055 (0036)	High peak display	HPEH	Same as parameter setting range	
400056 (0037)	Low peak display	LPEH		

• Func : Read Holding Register/Preset Single Register/Preset Multiple Register

### Input specification parameter setting/output value

Input spec.	Display	Value	Input spec.	Display	Value	
Thermocouple	EC - 0	0	RTD	CU50	12	
	EC - 1	1		CU10	13	
	EC - 2	2		JPE1	14	
	EC - 3	3		dPE5	15	
	EC - 4	4	dPE1	16		
	EC - 5	5	Analog	Current	RnR1	17
	EC - 6	6			RnR2	18
	EC - 7	7			Rnu1	19
	EC - 8	8		Rnu2	20	
	EC - 9	9		R-u1	21	
	EC - 10	10		R-u2	22	
EC - 11	11					

### Input Special Function

When selecting analog input, this function is to display the calculated actual value by square, root ( $\sqrt{\quad}$ ), or two unit function (TUF) as display value.

Name	Parameter	Function	Graph	Applications
Linear	Lin	Outputs as input value		Standard characteristics. Input for linearity.
Root	root	Outputs the rooted ( $\sqrt{\quad}$ ) input value		Used for measuring flows by pressure signal.
Square	SQR	Outputs the squared input value		Used for outputting differential pressure by flow signal.
Two unit	TUF	Display the pressure of under atmospheric pressure as mmHg unit		

### Input Digital Filter

Moving average digital filter is able to stably display and output the noise from input line and irregular signals as software.

- Display cycle is same when executing moving average digital filter.

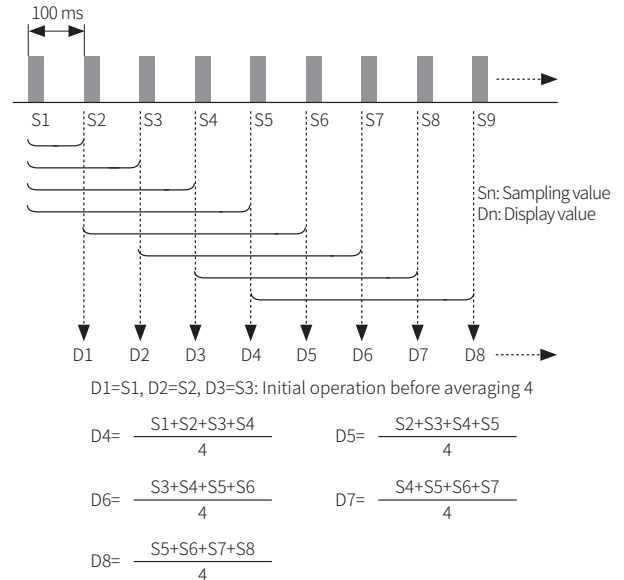

## Function: High / Low-limit scale value

This function is to display setting of particular high / low-limit value in order to display high / low-limit value of measured input.  
If measured inputs are a and b and particular values are A and B, it will display a = A, b = B as below graphs.

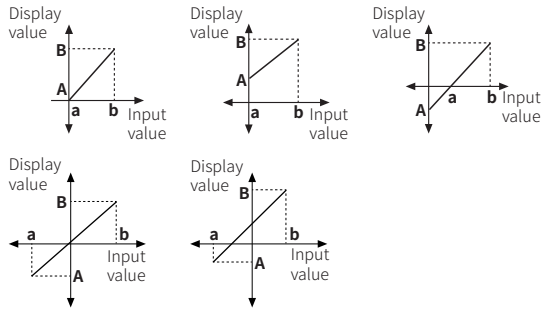

## Function: Alarm

888.8

Alarm operation Alarm option

Set both alarm operation and alarm option by combining. Each alarm operates individually in two alarm output models. When the current temperature is out of alarm range, alarm clears automatically.

### Operation

• H: Alarm output hysteresis

Mode	Name	Alarm operation	Description
R E 0	-	-	No alarm output
R E 1	Absolute value high limit	 Absolute value: Set as 90°C	 Absolute value: Set as 110°C
		 Absolute value: Set as 90°C	 Absolute value: Set as 110°C
R E 2	Absolute value low limit	 Absolute value: Set as 90°C	 Absolute value: Set as 110°C
		 Absolute value: Set as 90°C	 Absolute value: Set as 110°C
S b R	Sensor break	-	It will be ON when it detects sensor disconnection.

### Option

Mode	Name	Description	Condition of reapply
R	Standard alarm	If it is an alarm condition, alarm output is ON. If it is a clear alarm condition, alarm output is OFF.	-
b	Alarm latch	If it is an alarm condition, alarm output is ON and maintains ON status.	-
C	Standby sequence	When power is supplied and it is an alarm condition, this first alarm condition is ignored and from the second alarm condition, standard alarm operates.	Power ON
d	Alarm latch and standby sequence	If it is an alarm condition, it operates both alarm latch and standby sequence. When power is supplied and it is an alarm condition, this first alarm condition is ignored and from the second 1alarm condition, alarm latch operates.	

## Segment Table

The segments displayed on the product indicate the following meanings. It may differ depending on the product.

7 Segment	11 Segment	12 Segment	16 Segment
0	0	0	0
1	1	1	1
2	2	2	2
3	3	3	3
4	4	4	4
5	5	5	5
6	6	6	6
7	7	7	7
8	8	8	8
9	9	9	9
A	A	A	A
b	b	b	b
C	C	C	C
d	d	d	d
E	E	E	E
F	F	F	F
G	G	G	G
H	H	H	H