

Bar Graph Temperature Controllers



KPN Series PRODUCT MANUAL

For your safety, read and follow the considerations written in the instruction manual, other manuals and Autonics website.

The specifications, dimensions, etc are subject to change without notice for product improvement. Some models may be discontinued without notice.

Features

- High speed sampling of 50ms and $\pm 0.3\%$ display accuracy
- Enable to check control output operation amount by adopting bar graph
- Simultaneous heating/cooling control and automatic/manual control for high performance control
- Selection function of current output or SSR drive output
- Parameter setting available via PC (USB and RS485 communication)
 - Free device comprehensive management program (DAQMaster)
- Communication converter sold separately:
 - SCM-US (USB/Serial converter), SCM-381 (RS232C/RS485 converter) SCM-US481 (USB/RS485 converter)
- Multi-SV (Max. 4) function (select via digital input terminal)
- Heater break alarm
- CT sold separately: CSTC-E80LN, CSTC-E200LN, CSTS-E80PP
- Small size (rear length: 60 mm)
- Multi input/multi range

Safety Considerations

- Observe all 'Safety Considerations' for safe and proper operation to avoid hazards.
- **⚠** symbol indicates caution due to special circumstances in which hazards may occur.

⚠ Warning Failure to follow instructions may result in serious injury or death

- 01. Fail-safe device must be installed when using the unit with machinery that may cause serious injury or substantial economic loss.** (e.g. nuclear power control, medical equipment, ships, vehicles, railways, aircraft, combustion apparatus, safety equipment, crime/disaster prevention devices, etc.)
Failure to follow this instruction may result in personal injury, economic loss or fire.
- 02. Do not use or store the unit in the place where flammable/explosive/corrosive gas, high humidity, direct sunlight, radiant heat, vibration, impact or salinity may be present.**
Failure to follow this instruction may result in explosion or fire.
- 03. Install on a device panel to use.**
Failure to follow this instruction may result in electric shock.
- 04. Do not connect, repair, or inspect the unit while connected to a power source.**
Failure to follow this instruction may result in fire or electric shock.
- 05. Check 'Connections' before wiring.**
Failure to follow this instruction may result in fire.
- 06. Do not disassemble or modify the unit.**
Failure to follow this instruction may result in fire or electric shock.

⚠ Caution Failure to follow instructions may result in injury or product damage

- 01. When connecting the power input and relay output, use AWG 20 (0.50 mm²) cable or over, and tighten the terminal screw with a tightening torque of 0.74 to 0.90 N·m.**
When connecting the sensor input and communication cable without dedicated cable, use AWG 27 to 16 cable and tighten the terminal screw with a tightening torque of 0.74 to 0.90 N·m.
Failure to follow this instruction may result in fire or malfunction due to contact failure.
- 02. Use the unit within the rated specifications.**
Failure to follow this instruction may result in fire or product damage
- 03. Use a dry cloth to clean the unit, and do not use water or organic solvent.**
Failure to follow this instruction may result in fire or electric shock.
- 04. Keep the product away from metal chip, dust, and wire residue which flow into the unit.**
Failure to follow this instruction may result in fire or product damage.

Cautions during Use

- Follow instructions in 'Cautions during Use'. Otherwise, it may cause unexpected accidents.
- Check the polarity of the terminals before wiring the temperature sensor. For RTD temperature sensor, wire it as 3-wire type, using cables in same thickness and length. For thermocouple (CT) temperature sensor, use the designated compensation wire for extending wire.
- Keep away from high voltage lines or power lines to prevent inductive noise. In case installing power line and input signal line closely, use line filter or varistor at power line and shielded wire at input signal line. Do not use near the equipment which generates strong magnetic force or high frequency noise.

- Do not apply excessive power when connecting or disconnecting the connectors of the product.
- Install a power switch or circuit breaker in the easily accessible place for supplying or disconnecting the power.
- Do not use the unit for other purpose (e.g. voltmeter, ammeter), but temperature controller.
- When changing the input sensor, turn off the power first before changing. After changing the input sensor, modify the value of the corresponding parameter.
- Power supply should be insulated and limited voltage/current or Class 2, SELV power supply device.
- Do not overlapping communication line and power line. Use twisted pair wire for communication line and connect ferrite bead at each end of line to reduce the effect of external noise.
- Make a required space around the unit for radiation of heat. For accurate temperature measurement, warm up the unit over 20 min after turning on the power.
- Make sure that power supply voltage reaches to the rated voltage within 2 sec after supplying power.
- Do not wire to terminals which are not used.
- This unit may be used in the following environments.
 - Indoors (in the environment condition rated in 'Specifications')
 - Altitude Max. 2,000 m
 - Pollution degree 2
 - Installation category II

Ordering Information

This is only for reference, the actual product does not support all combinations. For selecting the specified model, follow the Autonics website.

K P N 5 ① ② - ③ ④ ⑤

① Size

- 2: DIN W 96 × H 48 mm
- 3: DIN W 48 × H 96 mm
- 5: DIN W 96 × H 96 mm

② Control output

PN	Output number	Type	
		Heating: OUT1	Cooling: OUT2
00	1 (Heating or Cooling)	Relay, selectable current or SSR drive output	
11		Selectable current or SSR drive output	
13	2 (Heating & Cooling)	Selectable current or SSR drive output	Relay
17		Relay	Selectable current or SSR drive output
19		Relay	

③ Option Communication output

- 0: No
- 2: RS485
- ④ Option in/output
- 0: No
- 3: Transmission output + Remote SV

⑤ Power supply

- 0: 100-240 VAC

Product Components

- Product (+ bracket)
- Instruction manual

Manual

For proper use of the product, refer to the manuals and be sure to follow the safety considerations in the manuals. Download the manuals from the Autonics website.

Software

Download the installation file and the manuals from the Autonics website.



■ DAQMaster

DAQMaster is comprehensive device management program. It is available for parameter setting, monitoring.

Sold Separately

- Terminal protection cover: RHA / RLA-COVER
- Current transformer (CT)
- Communication Converter: SCM-US / SCM-38I / SCM-US48I / SCM-WF48

Specifications

Series		KPN Series
Power supply		100 - 240 VAC ~ 50/60 Hz
Permissible voltage range		90 to 110 % of rated voltage
Power consumption		≤ 15 VA
Sampling period		50 ms
Input specification		Refer to 'Input Type and Using Range.'
Option input	CT input	• 0.0-50.0 A (primary current measurement range) • CT ratio: 1/1,000
	Remote SV	1 - 5 VDC ≐ or 4 - 20 mA (Current Input: External resistance 250 Ω)
	Digital input	• Contact - ON: ≤ 2 kΩ, OFF: ≥ 90 kΩ • Non contact - residual voltage ≤ 1.0 V, leakage current ≤ 0.1 mA
Control output	Relay	250 VAC ~ 5 A 1a
	SSR	11 VDC ≐ ± 2 V, ≤ 20 mA
	Current	DC 4-20 mA or DC 0-20 mA (parameter), load resistance: ≤ 500 Ω
Alarm output	Relay	250 VAC ~ 3 A 1a
Option output	Transmission	DC 4 - 20 mA (load resistance: ≤ 500 Ω, output accuracy: ± 0.3% F.S. ± 1-digit)
	RS485 Comm.	Modbus RTU
Display type		7 segment (red, green), control output bar graph (red, green), LED type
Control type	Heating, Cooling	ON/OFF, P, PI, PD, PID Control
	Heating & Cooling	
Hysteresis		• Thermocouple, RTD: 1 to 100 (0.1 to 100.0) °C/°F • Analog: 1 to 100 digit
Proportional band (P)		0.1 to 999.9 °C/°F (0.1 to 999.9%)
Integral time (I)		0 to 9,999 sec
Derivative time (D)		0 to 9,999 sec
Control cycle (T)		• 0.1 to 120.0 sec [relay output model] • 1.0 to 120.0 sec [SSR drive output model]
Manual reset		0.0 to 100.0%
Relay life cycle	Mechanical	≥ 10,000,000 operations
	Electrical	≥ 100,000 operations (load resistance: 250 VAC ~ 3 A)
Dielectric strength		Between the charging part and the case: 3,000 VAC ~ 50/60 Hz for 1 minute
Vibration		0.75 mm amplitude at frequency of 5 to 55 Hz in each X, Y, Z direction for 2 hours
Insulation resistance		≥ 100 MΩ (500 VDC ≐ megger)
Noise immunity		± 2 kV square shaped noise (pulse width 1 μs) by noise simulator R-phase, S-phase
Memory retention		≈ 10 years (non-volatile semiconductor memory type)
Ambient temperature		-10 to 50 °C, storage: -20 to 60 °C (no freezing or condensation)
Ambient humidity		35 to 85%RH, storage: 35 to 85%RH (no freezing or condensation)
Protection structure		IP65 (front panel, IEC standards)
Insulation type		Double or reinforced insulation (mark:  , dielectric strength between the measuring input part and the power part: 2 kV)
Certification ⁰¹⁾		CE  
Unit weight (packaged)		• KPN52□-□: ≈ 160 g (≈ 230 g) • KPN53□-□: ≈ 160 g (≈ 230 g) • KPN55□-□: ≈ 220 g (≈ 316 g)

01) Certification attainment may vary depending on the model. Check the certification on the Autonics website.

Communication Interface

■ RS485

Comm. protocol	Modbus RTU
Connection type	RS485
Application standard	EIA RS485 compliance with
Maximum connection	31 units (address: 01 to 127)
Synchronous method	Asynchronous
Comm. Method	Two-wire half duplex
Comm. effective range	≤ 800 m
Comm. speed	2,400 / 4,800 / 9,600 (default) / 19,200 / 38,400 bps (parameter)
Response time	5 to 99 ms (default: 20 ms)
Start bit	1 bit (fixed)
Data bit	8 bit (fixed)
Parity bit	None (default), Odd, Even
Stop bit	1 bit, 2 bit (default)
EEPROM life cycle	≈ 1,000,000 operations (Erase / Write)

Input Type and Using Range

The setting range of some parameters is limited when using the decimal point display.

Input type	Decimal point	Display	Using range (°C)	Using range (°F)
Thermo-couple	K (CA)	1	-200 to 1,350	-328 to 2,462
		0.1	-199.9 to 999.9	-199.9 to 999.9
	J (IC)	1	-200 to 800	-328 to 1,472
		0.1	-199.9 to 800.0	-199.9 to 999.9
	E (CR)	1	-200 to 800	-328 to 1,472
		0.1	-199.9 to 800.0	-199.9 to 999.9
	T (CC)	1	-200 to 400	-328 to 752
		0.1	-199.9 to 400.0	-199.9 to 752.0
	B (PR)	1	0 to 1,800	32 to 3,272
	R (PR)	1	0 to 1,750	32 to 3,182
	S (PR)	1	0 to 1,750	32 to 3,182
	N (NN)	1	-200 to 1,300	-328 to 2,372
C (TT) ⁰¹⁾	1	0 to 2,300	32 to 4,172	
G (TT) ⁰²⁾	1	0 to 2,300	32 to 4,172	
RTD	L (IC)	1	-200 to 900	-328 to 1,652
		0.1	-199.9 to 900.0	-199.9 to 999.9
	U (CC)	1	-200 to 400	-328 to 752
		0.1	-199.9 to 400.0	-199.9 to 752.0
	Platinel II	1	0 to 1,390	32 to 2,534
	Cu50 Ω	0.1	-199.9 to 200.0	-199.9 to 392.0
	Cu100 Ω	0.1	-199.9 to 200.0	-199.9 to 392.0
	JPt100 Ω	1	-200 to 650	-328 to 1,202
		0.1	-199.9 to 650.0	-199.9 to 999.9
	DPt50 Ω	1	-200 to 650	-328 to 1,202
		0.1	-199.9 to 650.0	-199.9 to 999.9
	DPt100 Ω	1	-200 to 650	-328 to 1,202
0.1		-199.9 to 650.0	-199.9 to 999.9	
Nickel120 Ω	1	-80 to 200	-112 to 392	
Analog	0 to 10V	-	0~ 10 V	
	0 to 5V	-	0~ 5 V	
	1 to 5 V	-	1~ 5 V	
	0 to 100 mV	-	0~ 100 mV	
	0 to 20 mA	-	0~ 20 mA	
	4 to 20 mA	-	4~ 20 mA	

01) C (TT): Same as existing W5 (TT) type sensor

02) G (TT): Same as existing W (TT) type sensor

• Permissible line resistance per line: ≤ 5 Ω

Display accuracy

Input type	Using temperature	Display accuracy
Thermo-couple RTD	At room temperature (23°C ± 5 °C)	(PV ± 0.3% or ± 1 °C higher one) ± 1-digit • Thermocouple K, J, T, N, E below -100 °C and L, U, PLII, RTD Cu50 Ω, DPt50 Ω: (PV ± 0.3% or ± 2 °C higher one) ± 1-digit • Thermocouple C, G and R, S below 200 °C: (PV ± 0.3% or ± 3 °C higher one) ± 1-digit • Thermocouple B below 400 °C: There is no accuracy standards
	Out of room temperature range	(PV ± 0.5% or ± 2 °C higher one) ± 1-digit • RTD Cu50 Ω, DPt50 Ω: (PV ± 0.5% or ± 3 °C higher one) ± 1-digit • Thermocouple R, S, B, C, G: (PV ± 0.5% or ± 10 °C higher one) ± 1-digit • Other sensors: ≤ ± 5 °C (≤ -100 °C)
Analog	At room temperature (23°C ± 5 °C)	± 0.3% F.S. ± 1-digit
	Out of room temperature range	± 0.5% F.S. ± 1-digit

Unit Descriptions

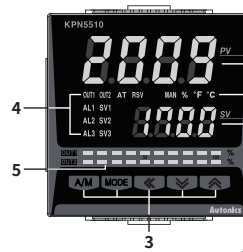

1. PV display part (Red)

- Run mode: Displays PV (Present value).
- Setting mode: Displays parameter name.

2. SV display part (Green)

- Run mode: Displays SV (Setting value).
- Setting mode: Displays parameter setting value.

3. Input key

Display	Name
[A/M]	Control Switching key
[MODE]	Mode key
[◀], [▼], [▲]	Setting value control key

4. Indicator

Display	Name	Description
MAN	Manual control	Turns ON during manual control
%, °F, °C	Unit	Displays selected unit (parameter)
OUT1/2	Control output	Turns ON when the control output is ON • Current output Manual control: 0% OFF, over ON Auto control: below 2% OFF, over 3% ON
AT	Auto tuning	Flashes during auto tuning every 1 sec
RSV	Remote SV	Turns ON during remote SV control
AL1/2/3	Alarm output	Turns ON when the alarm output is ON
SV1/2/3	Multi SV	The SV indicator is ON which is currently displayed. (When using multi SV function)

5. Bar graph: Refer to 'Bar Graph'.

6. PC loader port: For connecting communication converter (sold separately).

Bar Graph

MV of control output (OUT1, OUT2) is displayed as the bar graph in real-time. According to bar graph setting in parameter 5 group, it displays bar graph by control output or does not display it.

OUT1 (Red LED)

OUT2 (Green LED)

One LED is 10% (total 10 LEDs: 100%). If control output MV is 0.1 to 10%, one LED turns ON. If MV is 90.1 to 100%, 10 LEDs turn ON.

The 1 output type (heating or cooling control) model has one OUT1 bar graph (red).

The 2 output type (heating & cooling control) model has two bar graphs: OUT1 bar graph (red), OUT2 bar graph (green). OUT1 is for heating MV and OUT2 is for cooling MV.

Dimensions

- Unit: mm, For the detailed drawings, follow the Autonics website.
- Below is based on KPN52□-□ Series.

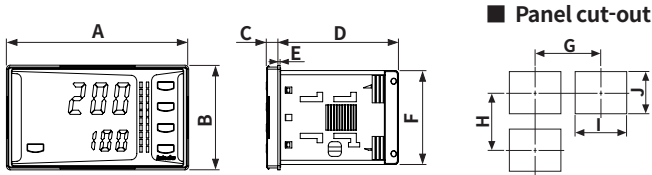

	Body						Panel cut-out			
	A	B	C	D	E	F	G	H	I	J
KPN52□-□	96	48	6	64.5	1.5	44.7	≥ 115	≥ 65	92 ^{+0.8} ₀	45 ^{+0.6} ₀
KPN53□-□	48	96	6	64.5	1.5	91.5	≥ 65	≥ 115	45 ^{+0.6} ₀	92 ^{+0.8} ₀
KPN55□-□	96	96	6	64.5	1.5	91.5	≥ 115	≥ 115	92 ^{+0.8} ₀	92 ^{+0.8} ₀

Bracket

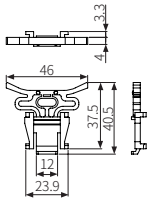

Installation Method

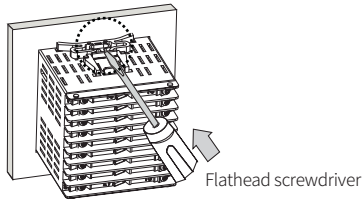

Insert the unit into a panel, fasten the bracket by pushing with tools with a flathead screwdriver.

Errors

Display	Input	Description	Output	Troubleshooting
oPE n	Temperature sensor	Flashes at 0.5 sec interval when input sensor is disconnected or sensor is not connected.	'Sensor error, MV' parameter setting value	Check input sensor status.
	Analog	Flashes at 0.5 sec interval when input is over F.S. ±10%.	'Sensor error, MV' parameter setting value	Check analog input status.
HHHH	Temperature sensor	Flashes at 0.5 sec intervals if the input value is above the input range. ⁰¹⁾	Heating: 0%, Cooling: 100%	When input is within the rated input range, this display disappears.
	Analog	Flashes at 0.5 sec intervals if the input value is over 5 to 10% of high limit or low limit value.	Normal output	
LLLL	Temperature sensor	Flashes at 0.5 sec. intervals if the input value is below the input range. ⁰¹⁾	Heating: 100%, Cooling: 0%	When input is within the rated input range, this display disappears.
	Analog	Flashes at 0.5 sec intervals if the input value is over 5 to 10% of low limit or high limit value.	Normal output	
Err	Temperature sensor	Flashes at 0.5 sec intervals if there is error for setting and it returns to the error-before screen.	-	Check setting method.
	Analog			

01) Be careful that when HHHH / LLLL error occurs, the control output may occur by recognizing the maximum or minimum input depending on the control type.

Connections

- Shaded terminals are standard model. □ is option specification.

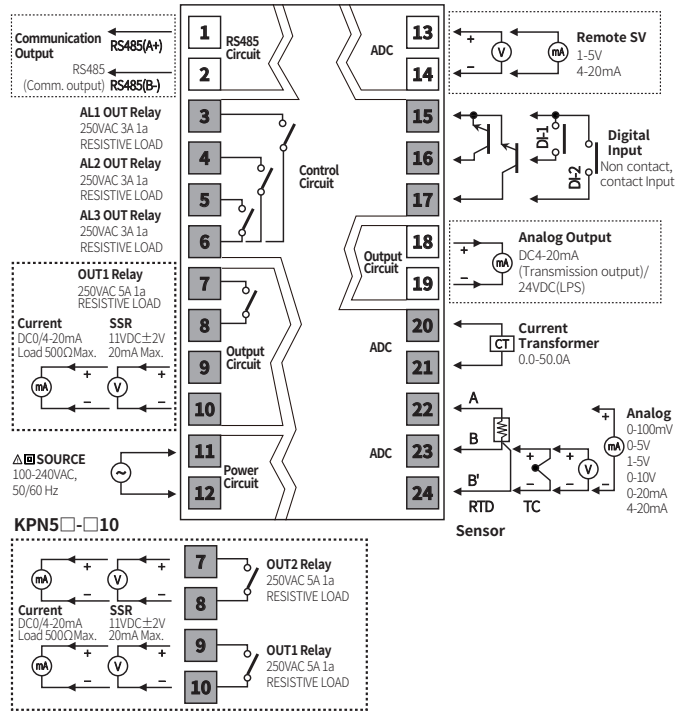

Crimp Terminal Specifications

- Unit: mm, Use the crimp terminal of follow shape.

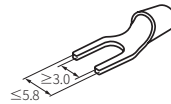

Fork crimp terminal

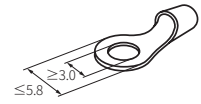

Round crimp terminal

Initial Display When Power is ON

When power is supplied, after all display will flash for 1 sec, model name is displayed sequentially. After input sensor type will flash twice, enter into RUN mode.

	1. All display	2. Model	3. Input specification	4. Run mode
PV display part	8.8.8.8	EP53	EP53	oPE n
SV display part	8.8.8.8	11.23	EC.1	0

Mode Setting

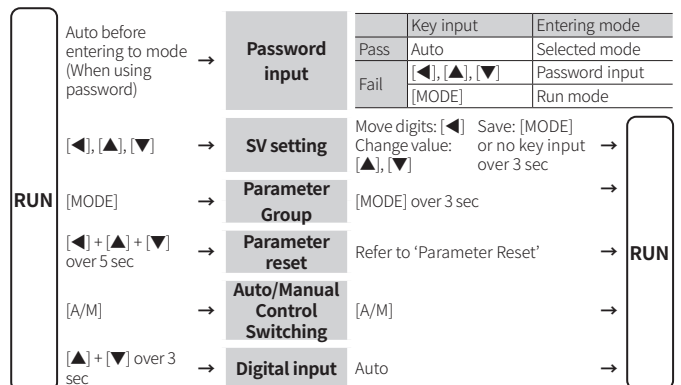

Parameter Reset

- Press the [◀] + [▲] + [▼] keys for over 5 sec. in run mode, INIT turns ON.
- Change the setting value as YES by pressing the [▲], [▼] keys.
- Press the [MODE] key to reset all parameter values as default and to return to run mode.

Parameter Setting

- Some parameters are activated/deactivated depending on the model or setting of other parameters.
- The 'Parameter mask' feature, which hide unnecessary or inactive parameters, and the 'User parameter group' feature, which quickly and easily set up certain parameters that are frequently used, can be set up in DAQMaster.
- Refer to the user manual for the details.

Parameter 1 group

Parameter	Display	Default
Control output RUN/STOP	r - 5	r Un
Multi SV selection	5 u - n	5 u - 0
Heater current monitoring	C t - R	0 0
Alarm output1 low limit	AL L L	155 0
Alarm output1 high limit	AL L H	155 0
Alarm output2 low limit	AL 2 L	155 0
Alarm output2 high limit	AL 2 H	155 0
Alarm output3 low limit	AL 3 L	155 0
Alarm output3 high limit	AL 3 H	155 0
Multi SV 0	5 u - 0	0 0 0 0
Multi SV 1	5 u - 1	0 0 0 0
Multi SV 2	5 u - 2	0 0 0 0
Multi SV 3	5 u - 3	0 0 0 0

Parameter 2 group

Parameter	Display	Default
Auto tuning RUN/STOP	At	o F F
Heating proportional band	H - P	0 1 0 0
Cooling proportional band	C - P	0 1 0 0
Heating integral time	H - I	0 0 0 0
Cooling integral time	C - I	0 0 0 0
Heating derivative time	H - d	0 0 0 0
Cooling derivative time	C - d	0 0 0 0
Dead overlap band	db	0 0 0 0
Manual reset	r E S t	0 5 0 0
Heating hysteresis	H H Y S	0 0 2
Heating OFF offset	H o S t	0 0 0
Cooling hysteresis	C H Y S	0 0 2
Cooling OFF offset	C o S t	0 0 0
MV low limit	L - n u	1 0 0 0
MV high limit	H - n u	1 0 0 0
RAMP up change rate	r A n U	0 0 0
RAMP down change rate	r A n d	0 0 0
RAMP time unit	r U n t	n i n

Parameter 3 group

Parameter	Display	Default
Input specification	I n - t	t C t i
Temperature unit	U n i t	° C
Analog low limit	L - r G	0 0 0 0
Analog high limit	H - r G	1 0 0 0
Scaling decimal point	d o t	0 0
Low limit scale	L - S C	0 0 0 0
High limit scale	H - S C	1 0 0 0
Display unit	d U n t	° P a
Input correction	I n - b	0 0 0 0
Input digital filter	n A u F	0 0 0 . 1
SV low limit	L - S u	- 2 0 0
SV high limit	H - S u	1 3 5 0

Control output mode	o - F t	HEAt (Output number: 1) H - C (Output number: 2)
Control type	C - n d	P i d (Output number: 1) P P (Output number: 2)
Auto tuning mode	At.t	r L Y (Output number: 1) 5 5 r (Output number: 2)
OUT1 control output selection	o U t 1	5 5 r (Output number: 2)
OUT1 current output range	o I n R	4 - 2 0
OUT2 control output selection	o U t 2	5 5 r
OUT2 current output range	o 2 n R	4 - 2 0
Heating control cycle	H - t	0 2 0 0 (Relay)
Cooling control cycle	C - t	0 0 2 0 (SSR)

Parameter 4 group

Parameter	Display	Default
Alarm output1 operation mode	AL - 1	d u C C
Alarm output1 option	AL L t	AL - R
Alarm output1 Hysteresis	A L H Y	0 0 1
Alarm output1 contact type	A L n	n o
Alarm output1 ON delay time	A L o n	0 0 0 0
Alarm output1 OFF delay time	A L o F	0 0 0 0
Alarm output2 operation mode	AL - 2	C C d u
Alarm output2 option	AL 2 t	AL - R
Alarm output2 hysteresis	A 2 H Y	0 0 1
Alarm output2 contact type	A 2 n	n o
Alarm output2 ON delay time	A 2 o n	0 0 0 0
Alarm output2 OFF delay time	A 2 o F	0 0 0 0
Alarm output3 operation mode	AL - 3	L b R
Alarm output3 option	AL 3 t	AL - R
Alarm output3 hysteresis	A 3 H Y	0 0 1
Alarm output3 contact type	A 3 n	n o
Alarm output3 ON delay time	A 3 o n	0 0 0 0
Alarm output3 OFF delay time	A 3 o F	0 0 0 0
LBA time	L b A t	0 0 0 0
LBA band	L b A b	0 0 3
Analog transmission output	A o n	P u
PV transmission output low limit	F 5 - L	- 2 0 0
PV transmission output high limit	F 5 - H	1 3 5 0
Communication address	A d r S	0 1
Communication speed	b P S	9 6
Comm. parity bit	P r t y	n o n E
Comm. stop bit	S t P	2
Response time	r S Y t	2 0
Comm. write	C o n W	E n R

Parameter 5 group

Parameter	Display	Default
Multi SV number	n t . S u	1
Digital input key	d i - t	At
Digital input1 Terminal Function	d i - 1	o F F
Digital input2 Terminal Function	d i - 2	o F F
Remote SV	r E S u	o F F
Remote SV low limit correction	r I n b	0 0 0 0
Remote SV high limit gradient correction	r S P n	1 0 0 0
Bar graph	b A R	o U t 1 (Output number: 1) A L L (Output number: 1)
Manual control, initial MV	I t n u	A U t o
Manual control, preset MV	P r . n u	0 0 0 0
Sensor error, MV	E r . n u	0 0 0 0
Control stop, MV	S t . n u	0 0 0 0
Control stop, alarm output	S t . A L	C o n t
User level	U S E r	S t n d
SV setting lock	L C . S u	o F F
Parameter 1 group lock	L C . P 1	o F F
Parameter 2 group lock	L C . P 2	o F F
Parameter 3 group lock	L C . P 3	o F F
Parameter 4 group lock	L C . P 4	o F F
Parameter 5 group lock	L C . P 5	o F F
Password setting	P W d	0 0 0 0

Function: Alarm

Alarm output sets alarm operation and alarm option.
Each alarm operates individually in two alarm output models.
When the current temperature is out of alarm range, alarm clears automatically.

Operation

• H: Alarm output hysteresis

Mode	Name	Alarm operation	Description
o F F	-	-	No alarm output
d u C C	Deviation high limit		If deviation between PV and SV as high-limit is higher than set value of deviation temperature, the alarm output will be ON.
C C d u	Deviation low limit		If deviation between PV and SV as low limit is higher than set value of deviation temperature, the alarm output will be ON.
C C d u	Deviation high, low limit		If deviation between PV and SV as high/low-limit is higher than set value of deviation temperature, the alarm output will be ON.
C d u C	Deviation high, low limit reverse		If deviation between PV and SV is higher than the lower limit deviation set value and less than the upper limit deviation set value, the alarm output will be ON.
P u C C	Absolute value high limit		If PV is higher than the absolute value, the output will be ON.
C C P u	Absolute value low limit		If PV is lower than the absolute value, the output will be ON.
S b R	Sensor break	-	It will be ON when it detects sensor disconnection.
H b R	Heater break	-	It will be ON when it detects heater disconnection.
L b R	Loop break	-	It will be ON when it detects loop disconnection.

Option

Mode	Name	Description	Condition of reply
AL - R	Standard alarm	If it is an alarm condition, alarm output is ON. If it is a clear alarm condition, alarm output is OFF.	-
AL - b	Alarm latch	If it is an alarm condition, alarm output is ON and maintains ON status.	-
AL - C	Standby sequence 1	First alarm condition is ignored and from second alarm condition, standard alarm operates. When power is supplied and it is an alarm condition, this first alarm condition is ignored and from the second alarm condition, standard alarm operates.	Power ON
AL - d	Alarm latch and standby sequence 1	If it is an alarm condition, it operates both alarm latch and standby sequence. When power is supplied and it is an alarm condition, this first alarm condition is ignored and from the second 1alarm condition, alarm latch operates.	Power ON
AL - E	Standby sequence 2	First alarm condition is ignored and from second alarm condition, standard alarm operates. When re-applied standby sequence and if it is alarm condition, alarm output does not turn ON. After clearing alarm condition, standard alarm operates.	Power ON, change SV, change alarm temperature / operation or change STOP to RUN mode
AL - F	Alarm latch and standby sequence 2	Basic operation is same as alarm latch and standby sequence1. It operates not only by power ON/OFF, but also alarm set value, or alarm option changing. When re-applied standby sequence and if it is alarm condition, alarm output does not turn ON. After clearing alarm condition, alarm latch operates.	Power ON, change SV, change alarm temperature / operation or change STOP to RUN mode

Sold Separately: Terminal Protection Cover

• Unit: mm

RHA-COVER: DIN W48 × H96

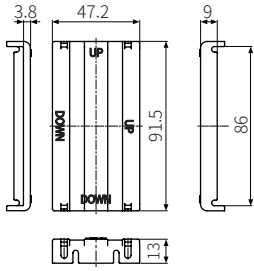

RLA-COVER: DIN W96 × H96

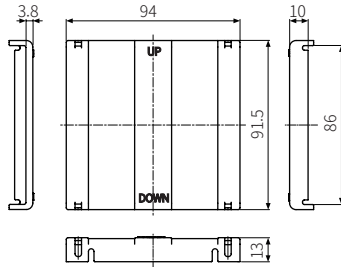

Sold Separately: Current Transformer (CT)

- Unit: mm
- The current for above CTs is 50A same but inner hole sizes are different. Please use this for your environment.
- Do not supply primary current in case that CT output is open. High voltage will be generated in CT output.

CSTC-E80LN

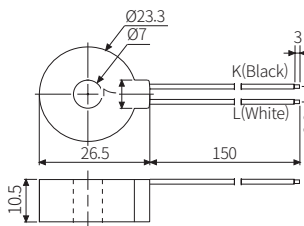

- Max. load current: 80A (50/60Hz)
- Current ratio: 1/1000
- Wire wounded resistance: 31Ω ±10%

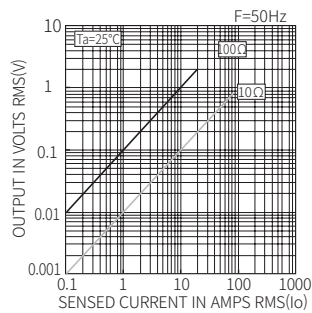

CSTC-E200LN

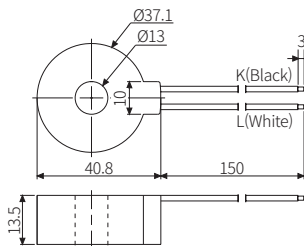

- Max. load current: 200A (50/60Hz)
- Current ratio: 1/1000
- Wire wounded resistance: 20Ω ±10%

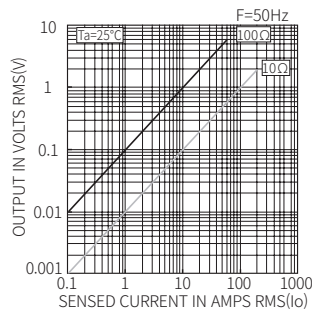

CSTS-E80PP

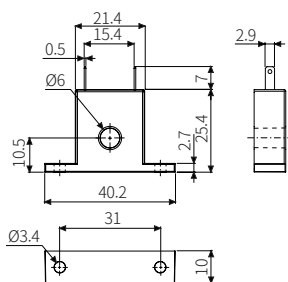

- Max. load current: 80A (50/60Hz)
- Current ratio: 1/1000
- Wire wounded resistance 31Ω ±10%

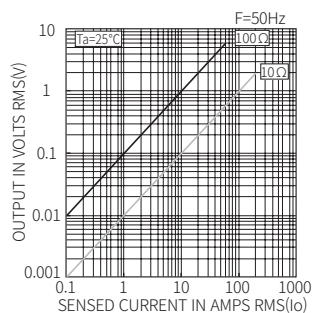

Segment Table

The segments displayed on the product indicate the following meanings. It may differ depending on the product.

7 Segment				11 Segment				12 Segment				16 Segment			
0	0	1	1	0	0	1	1	0	0	1	1	0	0	1	1
1	1	2	2	1	1	2	2	1	1	2	2	1	1	2	2
2	2	3	3	2	2	3	3	2	2	3	3	2	2	3	3
3	3	4	4	3	3	4	4	3	3	4	4	3	3	4	4
4	4	5	5	4	4	5	5	4	4	5	5	4	4	5	5
5	5	6	6	5	5	6	6	5	5	6	6	5	5	6	6
6	6	7	7	6	6	7	7	6	6	7	7	6	6	7	7
7	7	8	8	7	7	8	8	7	7	8	8	7	7	8	8
8	8	9	9	8	8	9	9	8	8	9	9	8	8	9	9
9	9	A	A	9	9	A	A	9	9	A	A	9	9	A	A
A	A	B	B	A	A	B	B	A	A	B	B	A	A	B	B
B	B	C	C	B	B	C	C	B	B	C	C	B	B	C	C
C	C	D	D	C	C	D	D	C	C	D	D	C	C	D	D
D	D	E	E	D	D	E	E	D	D	E	E	D	D	E	E
E	E	F	F	E	E	F	F	E	E	F	F	E	E	F	F
F	F	G	G	F	F	G	G	F	F	G	G	F	F	G	G
G	G	H	H	G	G	H	H	G	G	H	H	G	G	H	H
H	H	I	I	H	H	I	I	H	H	I	I	H	H	I	I
I	I	J	J	I	I	J	J	I	I	J	J	I	I	J	J
J	J	K	K	J	J	K	K	J	J	K	K	J	J	K	K
K	K	L	L	K	K	L	L	K	K	L	L	K	K	L	L
L	L	M	M	L	L	M	M	L	L	M	M	L	L	M	M
M	M	N	N	M	M	N	N	M	M	N	N	M	M	N	N
N	N	O	O	N	N	O	O	N	N	O	O	N	N	O	O
O	O	P	P	O	O	P	P	O	O	P	P	O	O	P	P
P	P	Q	Q	P	P	Q	Q	P	P	Q	Q	P	P	Q	Q
Q	Q	R	R	Q	Q	R	R	Q	Q	R	R	Q	Q	R	R
R	R	S	S	R	R	S	S	R	R	S	S	R	R	S	S
S	S	T	T	S	S	T	T	S	S	T	T	S	S	T	T
T	T	U	U	T	T	U	U	T	T	U	U	T	T	U	U
U	U	V	V	U	U	V	V	U	U	V	V	U	U	V	V
V	V	W	W	V	V	W	W	V	V	W	W	V	V	W	W
W	W	X	X	W	W	X	X	W	W	X	X	W	W	X	X
X	X	Y	Y	X	X	Y	Y	X	X	Y	Y	X	X	Y	Y
Y	Y	Z	Z	Y	Y	Z	Z	Y	Y	Z	Z	Y	Y	Z	Z
Z	Z			Z	Z			Z	Z			Z	Z		