

Thumbwheel Switch Multi Pulse Meters



MP5M Series PRODUCT MANUAL

For your safety, read and follow the considerations written in the instruction manual, other manuals and Autonics website.

The specifications, dimensions, etc. are subject to change without notice for product improvement. Some models may be discontinued without notice.

Features

- 14 operation modes
 - Frequency / revolutions / speed, passing speed, cycle, passing time, time interval
 - Time differential, absolute ratio, density, length measurement 1 / 2, interval
 - Accumulation, addition / subtraction (individual input), addition / subtraction (phase difference input)
- Various output models
 - Relay single (high-limit) / double (high / low-limit) + NPN open collector output
- Various functions
 - Prescale, monitoring delay, hysteresis, auto-zero, parameter lock
- NPN input (non-contact / contact) or PNP input (non-contact / contact)
- Display range: -19999 to 99999
- Various display units
- Power supply
 - 100 - 240 VAC ~ 50 / 60Hz (AC type)
 - 24 VAC ~ 50 / 60 Hz, 24 - 48 VDC = (AC / DC type)

Safety Considerations

- Observe all 'Safety Considerations' for safe and proper operation to avoid hazards.
- ⚠ symbol indicates caution due to special circumstances in which hazards may occur.

⚠ Warning Failure to follow instructions may result in serious injury or death.

- 01. Fail-safe device must be installed when using the unit with machinery that may cause serious injury or substantial economic loss. (e.g. nuclear power control, medical equipment, ships, vehicles, railways, aircraft, combustion apparatus, safety equipment, crime / disaster prevention devices, etc.)**
Failure to follow this instruction may result in personal injury, economic loss or fire.
- 02. Do not use or store the unit in the place where flammable / explosive / corrosive gas, high humidity, direct sunlight, radiant heat, vibration, impact, or salinity may be present.**
Failure to follow this instruction may result in explosion or fire.
- 03. Install on a device panel to use.**
Failure to follow this instruction may result in fire or electric shock.
- 04. Do not connect, repair, or inspect the unit while connected to a power source.**
Failure to follow this instruction may result in fire or electric shock.
- 05. Check 'Connections' before wiring.**
Failure to follow this instruction may result in fire.
- 06. Do not disassemble or modify the unit.**
Failure to follow this instruction may result in fire or electric shock.

⚠ Caution Failure to follow instructions may result in injury or product damage.

- 01. When connecting the power / measurement input and relay output, use AWG 24 (0.20 mm²) to AWG 15 (1.65 mm²) cable and tighten the terminal screw with a tightening torque of 0.98 to 1.18 N m.**
Use the wiring suitable for the load current capacity.
Failure to follow this instruction may result in fire or malfunction due to contact failure.
- 02. Use the unit within the rated specifications.**
Failure to follow this instruction may result in fire or product damage.
- 03. Use dry cloth to clean the unit, and do not use water or organic solvent.**
Failure to follow this instruction may result in fire or electric shock.
- 04. Keep the product away from metal chip, dust, and wire residue which from flowing into the unit.**
Failure to follow this instruction may result in fire or product damage.

Cautions during Use

- Follow instructions in 'Cautions during Use'. Otherwise, it may cause unexpected accidents.
- Power supply should be insulated and limited voltage / current or Class 2, SELV power supply device.
- Install a power switch or circuit breaker in the easily accessible place for supplying or disconnecting the power.
- Keep away from high voltage lines or power lines to prevent inductive noise. In case installing power line and input signal line closely, use line filter or varistor at power line and shielded wire at input signal line. Do not use near the equipment which generates strong magnetic force or high frequency noise.
- This unit may be used in the following environments.
 - Indoors (in the environment condition rated in 'Specifications')
 - Altitude max. 2,000 m
 - Pollution degree 2
 - Installation category II

Ordering Information

This is only for reference, the actual product does not support all combinations.
For selecting the specified model, follow the Autonics website.

MP 5 M - ① ②

① Power supply

2: 24 VAC 50 / 60 Hz, 24 - 48 VDC
4: 100 - 240 VAC 50 / 60 Hz

② Output

N: Indicator
1: Relay single (high-limit) +
NPN open collector output
2: Relay double (high / low-limit) +
NPN open collector output

Product Components

- Product (+ bracket)
- Instruction manual

Sold Separately

- Terminal protection cover: RMA-COVER

Dimensions

- Unit: mm, For the detailed drawings, follow the Autonics website.

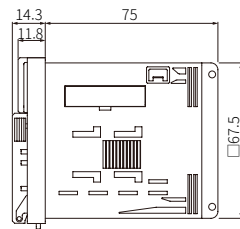
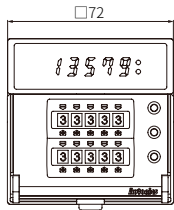

■ Bracket

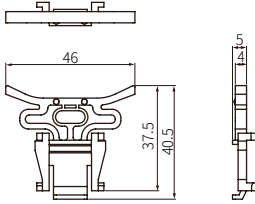

■ Panel cut-out

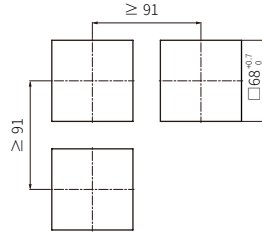

Connections

- HOLD / RESET terminal function is different depending on the operation mode. (F1 to F10: HOLD, F11 to F14: RESET)
- SOURCE: 100 - 240 VAC ~ 50 / 60 Hz 9 VA
24 VAC ~ 50 / 60 Hz 6.5 VA, 24 - 48 VDC ~ 5 W

■ Cautions during Wiring

- Unit: mm, Use terminals of size specified below.

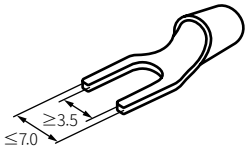

■ Indicator

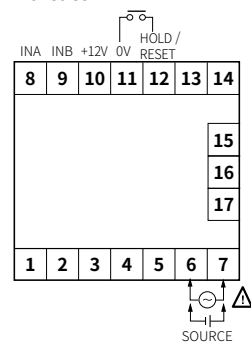

■ Relay single output

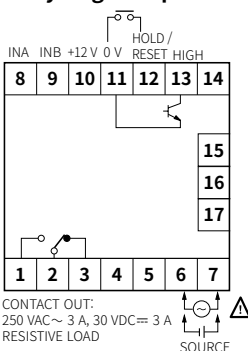

■ Relay double output

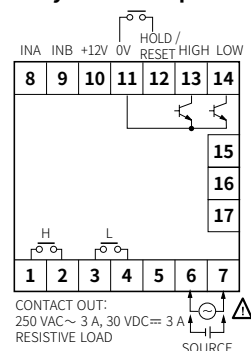

Specifications

Series	MP5M-□N	MP5M-□1	MP5M-□2
Input signal ⁽⁰¹⁾	Solid state input 1: ≤ 50 kHz (pulse width: ≥ 10 μs) Solid state input 2 ⁽⁰²⁾ : ≤ 5 kHz (pulse width: ≥ 100 μs) Contact input: ≤ 45 Hz (contact: ≥ 12 VDC ~ 5 mA, pulse width: ≥ 11 ms)		
Voltage input	Input impedance: 3.9 kΩ, [H]: 4.5 - 24 VDC ~, [L]: 0 - 1 VDC ~		
No-voltage input	Short-circuit impedance: ≤ 80 Ω, residual voltage: ≤ 1 VDC ~, open-circuit impedance: ≥ 100 kΩ		
Display method	7-segment LED (zero blanking method)		
Character size	W 4 × H 8 mm		
Prescale	0.0001 × 10 ³ to 9.9999 × 10 ⁹		
Hysteresis	- 0 to 9999 ⁽⁰³⁾		
Display cycle	OFF ⁽⁰⁴⁾ , 0.05, 0.5, 1, 2, 4, 8 sec (same as update output cycle)		
Display range	-19999 to 99999		
Contact control output	Relay		
Type	-	1c × 1	1a × 2
Capacity	-	250 VAC ~ 3 A, 30 VDC ~ 3 A resistive load	250 VAC ~ 3 A, 30 VDC ~ 3 A resistive load
Solid-state control output	NPN open collector		
Type	-	× 1	× 2
Capacity	-	≤ 30 VDC ~ 100 mA	≤ 30 VDC ~ 100 mA
Certification	CE, UKCA, RoHS, ENEC		
Unit weight (package)	≈ 168 g (≈ 243 g)	≈ 181 g (≈ 256 g)	≈ 190 g (≈ 265 g)

(01) Standard duty ratio 1:1

(02) Operation mode F7, F8: ≤ 1 kHz (pulse width: ≥ 500 μs)

(03) The hysteresis setting range varies according to the decimal point setting position.

(04) Only available operation mode F2, F14

	AC voltage	AC / DC voltage
Power supply	100 - 240 VAC ~ 50 / 60 Hz	24 VAC ~ 50 / 60 Hz, 24 - 48 VDC ~
Permissible voltage range	90 to 110 % of rated voltage	
Power consumption	≤ 9 VA	AC: ≤ 6.5 VA, DC: ≤ 5 W
External power supply	≤ 12 VDC ~ ± 10 % 80 mA	
Memory retention	Number of inputs: 100,000 operations (non-volatile semiconductor memory type)	
Relay life cycle	Mechanical: ≥ 5,000,000 operations Electrical: ≥ 100,000 operations (250 VAC ~ 3 A resistive load)	
Insulation resistance	≥ 100 MΩ (500 VDC ~ megger)	
Dielectric strength	Between the charging part and the case: 3,000 VAC ~ 60 Hz for 1 min	
Noise immunity	± 2 kV the square wave noise (pulse width: 1 μs) by the noise simulator	
Vibration	0.75 mm double amplitude at frequency of 10 to 55 Hz in each X, Y, Z direction for 1 hour	
Vibration (malfunction)	0.5 mm double amplitude at frequency of 10 to 55 Hz in each X, Y, Z direction for 10 min	
Shock	300m / s ² (≈ 30G) in each X, Y, Z direction for 3 times	
Shock (malfunction)	100m / s ² (≈ 30G) in each X, Y, Z direction for 3 times	
Ambient temperature	-10 to 50 °C, storage: -20 to 60 °C (no freezing or condensation)	
Ambient humidity	35 to 85 %RH, storage: 35 to 85 %RH (no freezing or condensation)	

Operation mode	Measurement range	Measurement accuracy (23 ± 5 °C)
F1 Frequency / revolutions / speed	0.0005 Hz to 50 kHz	F.S. ± 0.05 % rdg ± 1-digit
F2 Passing speed		
F3 Cycle		
F4 Passing time	0.01 to max. of each time range	F.S. ± 0.01 % rdg ± 1-digit
F5 Time interval		
F6 Time differential		
F7 Absolute ratio	0.0005 Hz to 50 kHz	F.S. ± 0.05 % rdg ± 1-digit
F8 Density		
F9 Length measurement 1	0 to 99999	-
F10 Interval		
F11 Accumulation		
F12 Addition / subtraction-individual input		
F13 Addition / subtraction-phase-difference input	-19999 to 99999	-
F14 Length measurement 2	0 to 99999	-

Mode Setting

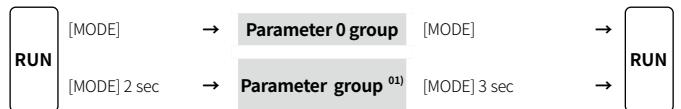

(01) Press [▲], [◀] key or [MODE] key for 1.5 sec after entering parameter: select parameter groups.

Parameter Setting

- Some parameters are activated / deactivated depending on the model or setting of other parameters. Refer to the description of each parameter.
- The parameter and setting value are cross-displayed on the display part.
- If any key is not entered for 60 sec in each parameter, it returns to RUN mode.
- [MODE] key: Saves current setting value and moves to the next parameter.
- [◀] key: Checks fixed value / Changes setting digits.
- [▲], [▶] key: Changes setting values.

■ Parameter 0 group

Parameter	Display	Default	Setting range	Display condition
P0-1 Max. monitoring value	H.P.E.L	99999	• Reset (PV): [◀] key for over 2 sec	P1-1 Input operation mode: except F11, F14
P0-2 Min. monitoring value	L.P.E.L	-19999		

Parameter 1 group

Parameter	Display	Default	Setting range	Display condition
P1-1 Input operation mode	nodE	F1	F1 to F14	-
P1-2 Input A sensor type	in-A	nPN.HF	NPN.H.F: NPN non-contact input1 NPN.M.F: NPN non-contact input2 NPN.L.F: NPN contact input	-
P1-3 Input B sensor type	in-b	nPN.HF	PNP.H.F: PNP non-contact input1 PNP.M.F: PNP non-contact input2 PNP.L.F: PNP contact input	P1-1 Input operation mode: F2, F6 to 12, F14 ⁽¹⁾
P1-4 Output mode	out-t	5tRRd	[Relay double output model] STARD: S (Standard) OUT-H: H (High) OUT-L: L (Low) OUT-B: B (Block) OUT-I: I (One-shot) OUT-F: F (Deflection) *	P1-1 Input operation mode: except F11 & * P1-1 Input operation mode: except F14
P1-5 Output hysteresis	HYS	0001	[Relay single / double output model] 0000 to 9999 • Varies according to P2-1 Decimal point position of display value	P1-1 Input operation mode: F1, F7 to 8
P1-6 Delay monitoring	GUARD	F.dEFY	[Relay double output model] F.DEFY: L comparative output limit * STAR.T: Start compensation timer ⁽²⁾	P1-1 Input operation mode: F1 to 10 *P1-4 Output mode: S, B, F
P1-7 Compensation time	5tRR.t	00	[Relay double output model] 0.0 to 99.9 sec	P1-6 Delay monitoring: STAR.T
P1-8 Input A auto-zero time	RUt.aR	9999.9	0.1 to 9999.9 sec	P1-1 Input operation mode: F1, F4, F7 to 8
P1-9 Input B auto-zero time	RUt.ab	9999.9		P1-1 Input operation mode: F7 to 8
P1-10 Memory retention	ne-o	oFF	OFF, ON	P1-1 Input operation mode: F11 to 14

01) In case of P1-1 Input operation mode F13, input B sensor type is not displayed and IN-B setting is same as IN-A.
02) key: Entering compensation time setting.

Parameter 2 group

Parameter	Display	Default	Setting range	Display condition
P2-1 Decimal point position of display value	d.o.t	00000	00000, 0000.0, 000.00, 00.000, 0.0000	P1-1 Input operation mode: F1 to 2, F7 to 14
P2-2 Time unit ⁽¹⁾	t.u.n.t	t.S.E.C	T.SEC, T.MIN	
P2-3 Time range (unit: sec) ⁽²⁾	t.S.E.C	99.999	999.99: 999.99 s 9999.9: 9999.9 s 99999: 99999 s	P1-1 Input operation mode: F3 to 6
P2-4 Time range (unit: min) ⁽²⁾	t.m.t.n	99.999	999.99: 999.99 m 9999.9: 9999.9 m 99999: 99999 m	
P2-5 Input A prescale mantissa (x)	P5C.R.H	6.0000	0.0001 to 9.9999	P1-1 Input operation mode: F1 to 2, F4, F7 to 14
P2-6 Input A prescale exponent (y)	P5C.R.Y	10 01	10 - 9 (10 ⁹) to 10 09 (10 ⁹)	
P2-7 Input B prescale mantissa (x)	P5C.b.H	6.0000	0.0001 to 9.9999	P1-1 Input operation mode: F7 to 8
P2-8 Input B prescale exponent (y)	P5C.b.Y	10 01	10 - 9 (10 ⁹) to 10 09 (10 ⁹)	
P2-9 Display cycle	d.t.SP.t	0.05	OFF ⁽²⁾ or 0.05, 0.5, 1, 2, 4, 8 sec	P1-1 Input operation mode: F1 to 2, F7 to 8, F14
P2-10 Input B setting value (INB)	C.o.U.n.b	9999.9	1 to 99999	P1-1 Input operation mode: F14

01) To enter P2-3 time range (unit: sec) and P2-4 time range (unit: min) setting, press key at P2-2 time unit.
02) Only available operation mode F2, F14

Parameter 3 group

Parameter	Display	Default	Setting range	Display condition
P3-1 Lock	LoC	oFF	OFF: Unlock LOC.0: Lock All LOC.1: Lock parameter 1 / 2 / 3 LOC.2: Lock parameter 2 / 3 LOC.3: Lock parameter 3	-
P3-2 Parameter reset	re.S.t	E.n.R	ENA: enable, DISA: disable	-

Sold Separately: Terminal Protection Cover

• Unit: mm

RMA-COVER: DIN W72 × H72

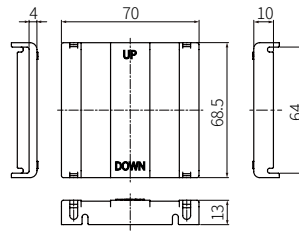

Output Mode

Output mode is available to set.

The output modes supported by each model are different.

- Indicator : not support output mode, Relay single output model: S (Standard),

Relay double output model: total output modes

ON: OFF: H: hysteresis

S (Standard) / B (Block) output mode

- Comparative value setting condition
S (Standard): individual output operation regardless of size or order of set comparative values
B (Block): L < H

H output: Display value ≥ Comparative value H
L output: Display value ≤ Comparative value L

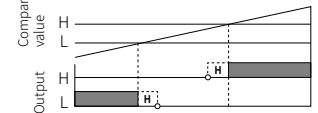

H (High) output mode

- Comparative value setting condition:
individual output operation regardless of size or order of set comparative values

H output: Display value ≥ Comparative value H
L output: Display value ≥ Comparative value L

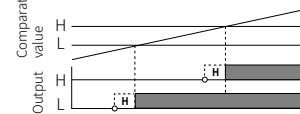

L (Low) output mode

- Comparative value setting condition:
individual output operation regardless of size or order of set comparative values

H output: Display value ≤ Comparative value H
L output: Display value ≤ Comparative value L

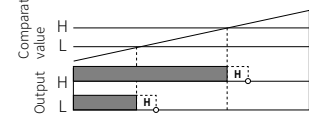

I (One-shot) output mode

- Comparative value setting condition:
individual output operation regardless of size or order of set comparative values
- One-shot output time: 0.3 sec (fixed)
- No hysteresis.

H output: Display value ≥ Comparative value H
L output: Display value ≥ Comparative value L

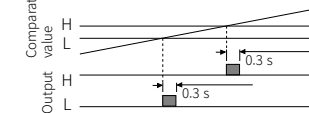

F (Deflection) output mode

- Transmits outputs when the saved setting value exceeds H deviation or L deviation.
- Comparative value setting
: Based on the set value, use the front HIGH / LOW set value thumbwheel switch to set the H / L deviation.
(The set deviation value is saved during Power OFF until it is re-set.)

• Comparative value setting range
: 0.0001 to 99999

The setting range is different according to the P2-1 Decimal point position of display value setting.

E.g.) In case of P2-1 Decimal point position of display value = 0000.0, setting range = 0.1 to 9999.9

• Saving setting value: [MODE] +

• Checking setting value:

• The deviation can be set to "0" but the actual operation will be the same as "1".

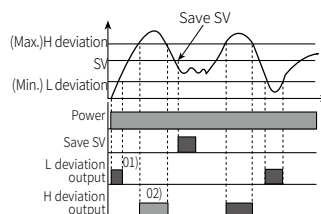

01) When P1-6 Delay monitoring = F.DEFY is set, there is no output.

02) The graph is assuming that there is a saved setting value prior to the setting value save point. The actual output position may be different.

Operation Mode

F1: frequency / revolutions / speed

Measures the frequency of input A and displays the calculated frequency, revolutions, and speed.

Frequency (Hz)	$= f \times \alpha$	($\alpha = 1$ [sec])	• L: travel distance of conveyor belt of 1 cycle [m]
Revolutions (rpm)	$= f \times \alpha$	($\alpha = 60$ [sec])	• α : prescale value
Speed (m / min)	$= f \times \alpha$	($\alpha = 60L$ [sec])	(For multiple objects, $\alpha = 60L / N$)

Display value	Display unit	α
Frequency	Hz	1
	kHz	0.001
Revolutions	rps	1
	rpm (default)	60
Speed	mm / sec	1,000 L
	cm / sec	100 L
	m / sec	1 L
	m / min	60 L
	km / hour	3.6 L

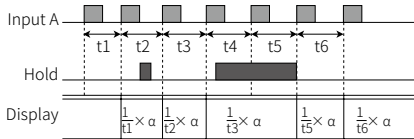
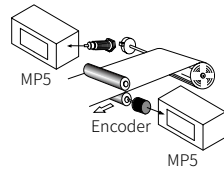

F2: passing speed

Displays the passing speed between input A ON and input B ON.

Passing speed (V)	$= f \times \alpha$	($\alpha = L$ [m])	• f: reciprocal of time [sec] between input A (sensor) ON and input B (sensor) ON.
			• L: distance between input A (sensor) and input B (sensor) [m]
			• α : prescale value

Display value	Display unit	α
Passing speed	mm / sec	1,000 L
	cm / sec	100 L
	m / sec (default)	1 L
	m / min	60 L
	km / hour	3.6 L

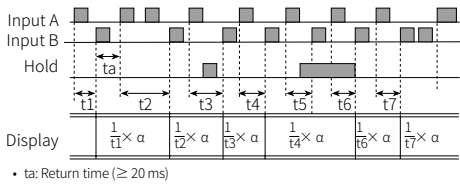
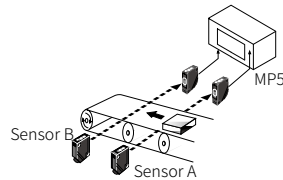

F3: cycle

Displays the measured time from input A ON to the next ON.

Cycle (T)	$= t$	• t: measurement time [sec]
-----------	-------	-----------------------------

Display value	Display unit	
Cycle	SEC	MIN
	999.99 s (default)	999.99 m
	9999.9 s	9999.9 m
	99999 s	99999 m

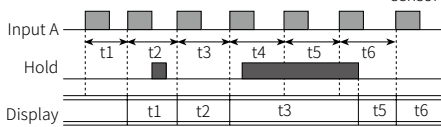
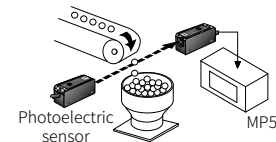

F4: passing time

Measure the time from input A ON to the next ON, and displays the passing time of the arbitrary distance.

Passing time [sec]	$= t \times \alpha$	• t: measurement time [sec]
		• L: arbitrary distance [m]
		• α : prescale value

Display value	Display unit	
Passing time	SEC	MIN
	999.99 s (default)	999.99 m
	9999.9 s	9999.9 m
	99999 s	99999 m

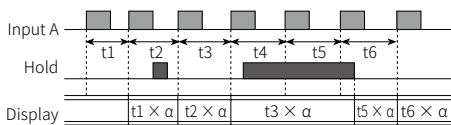
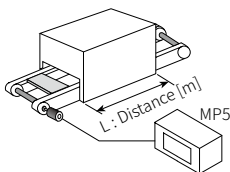

F5: time interval

Displays measured time of input A ON.

Time interval (T)	$= t$	• t: measured time of input A ON [sec]
-------------------	-------	--

Display value	Display unit	
Time interval	SEC	MIN
	999.99 s (default)	999.99 m
	9999.9 s	9999.9 m
	99999 s	99999 m

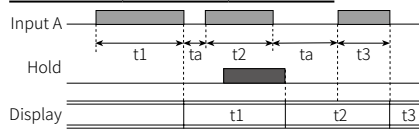
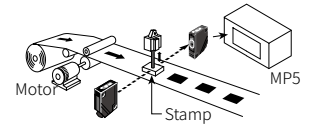

• ta: Return time (≥ 20 ms)

F6: time differential

Displays measured time from Input A ON to Input B ON.

Time differential (T)	$= t$ (ta to tb)	• t (ta to tb): measured time from input A ON to input B ON [sec]
-----------------------	------------------	---

Display value	Display unit	
Time differential	SEC	MIN
	999.99 s (default)	999.99 m
	9999.9 s	9999.9 m
	99999 s	99999 m

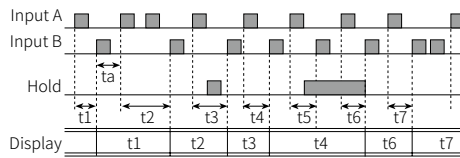
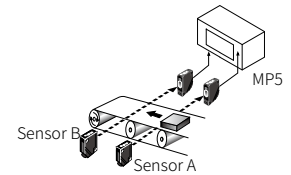

• ta: Return time (≥ 20 ms)

F7: absolute ratio

Measures and displays relative speed, amount, speed, etc. of input B against input A in percentage (%).

Absolute ratio	$= \frac{\text{Input B}}{\text{Input A}} \times 100 \%$	• Aa: prescale value of input A
		• Ba: prescale value of input B
Absolute ratio	$= \frac{\text{Frequency of input B [Hz]} \times Ba}{\text{Frequency of input A [Hz]} \times Aa} \times 100 \%$	

Display value	Display unit
Absolute ratio	%

Display = $\frac{\text{Frequency of input B [Hz]} \times Ba}{\text{Frequency of input A [Hz]} \times Aa} \times 100$ [%]

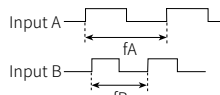
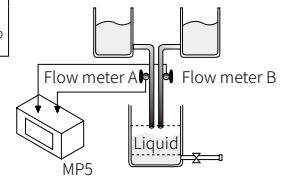

• Hold
When the hold signal turns ON, the display value is maintained until the display cycle turns to hold OFF.

F8: density

Measures and displays the density ratio (%) of input B against the total sum of input A and input B.

Density	$= \frac{\text{Input B}}{\text{Input A} + \text{Input B}} \times 100$ [%]	• Aa: prescale value of input A
		• Ba: prescale value of input B
Density	$= \frac{\text{Frequency of input B [Hz]} \times Ba}{(\text{frequency of input A [Hz]} \times Aa) + (\text{frequency of input B [Hz]} \times Ba)} \times 100$ [%]	

Display value	Display unit
Density	%

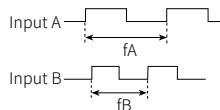
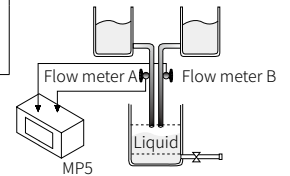

• Hold
When the hold signal turns ON, the display value is maintained until the display cycle turns to hold OFF.

F9: length measurement 1

Measure and display the number of input A pulses during input B ON.

$$\text{Length measurement 1} = P \times \alpha$$

- P: number of input A pulses
- α : prescale value

Display value	Display unit
Quantity [EA] (default)	
Length measurement 1	mm
	cm
	m

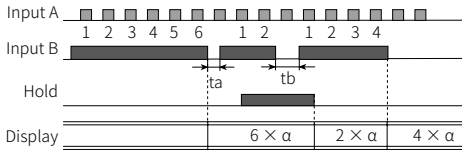
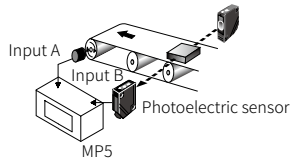

- ta, tb: Return time (≥ 20 ms)

F10: interval

Measures and displays the number of input A pulses from input B ON to the next ON.

$$\text{Interval} = P \times \alpha$$

- P: number of input A pulses
- α : prescale value

Display value	Display unit
Quantity [EA] (default)	
Interval	mm
	cm
	m

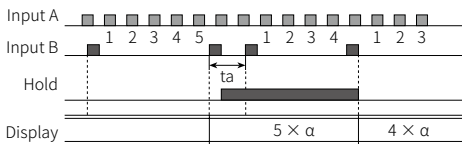
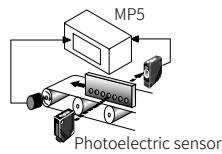

- ta: Return time (≥ 20 ms)

F11: accumulation

Measures and displays the counted value of input A pulses.

$$\text{Accumulation} = P \times \alpha$$

- P: number of input A pulses
- α : prescale value

Display value	Display unit
Accumulation	Quantity [EA]

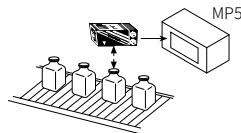

• Operation

- Counts the number of input A pulses.
- Input B is an enable input signal. During ON, the quantity and display value of input A will be held, and during OFF input A will be recounted.
- When RESET input is ON, the integrated counted value will be reset to "0"

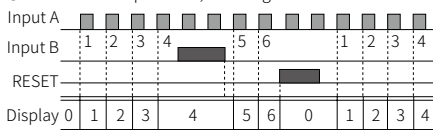

- α = display value for 1

F12: addition / subtraction-individual input

Displays the counted value from added input A pulses and subtracted input B pulses. When there are two inputs simultaneously, it will not count.

$$\text{Add / Sub (individual)} = \text{input A} \times \alpha - \text{input B} \times \alpha$$

- α : prescale value of input A

Display value	Display unit
Addition / Subtraction (individual)	Quantity [EA]

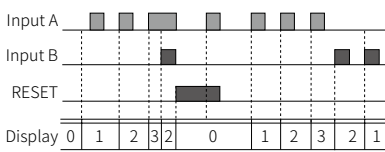
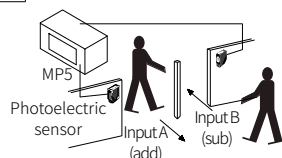

- α = display value for 1

F13: addition / subtraction-phase difference input

When input A is Low, counting is added to the low of input B. When input A is Low, counting is subtracted from the high of input B.

Add / Sub (phase difference) = Detects position and speed using A and B phases of encoder outputs as input.

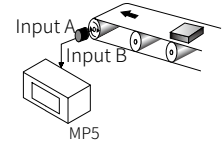

Display value	Display unit
Addition / Subtraction (phase difference)	Quantity [EA]

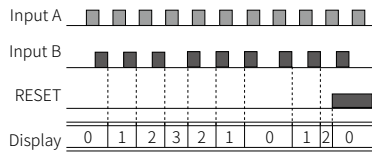

F14: length measurement 2

Measures and displays the number of pulses from input A until the value of input B reaches the setting value.

$$\text{Length measurement 2} = P \times \alpha \text{ (until the setting value of input B)}$$

- P: number of input A pulses
- α : prescale value

Display value	Display unit
Length measurement 2	Quantity [EA]

- If input A and input B are ON during initial power supply, it will not count and only count the number of rising edge.
- Display value is renewed depending on the P2-9. Display cycle.

(e.g.: input B = 4)

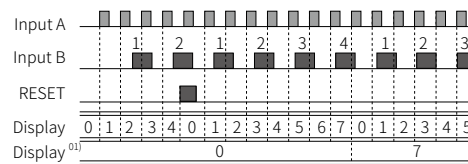

- 01) When P2-9 Display cycle is OFF, it will maintain the quantity of input A until the value of input B reaches the setting value of P2-10 Input B setting value (INB).

Functions

Hysteresis

Near the comparative setting value, the output may turn ON / OFF frequently and unstably. To prevent this, hysteresis value is set based on the comparative setting value.

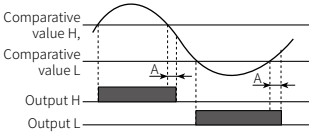

- A: hysteresis
- The hysteresis value can be set to "0" but the actual operation value is "1"

Delay monitoring: limit comparative output

After supplying power, the starting current of motors and other inputs are changeable. This function allows stable control by limiting all outputs for a certain period of time, until the target measurement unit stabilizes. It may also control L outputs until a specific output is reached.

- After supplying power, there is no initial L comparative outputs.
- Each setting value of H, L is not related to their relative sizes.
- E.g.: S (Standard) output mode

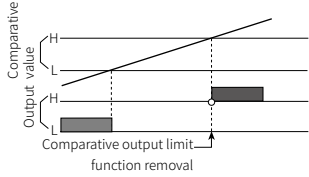

- E.g.: F (Deflection) output mode

The comparative output limiting function is removed at the set value (standard setting).

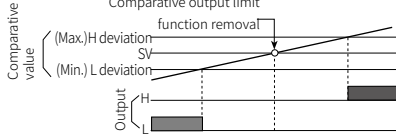

Delay monitoring: Start compensation timer

Set monitoring delay time so that there is no output during the delay time.

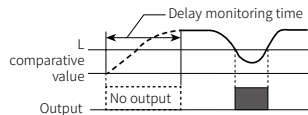

Auto-zero time

When there is no input signal during auto-zero setting time, the display value is automatically set to 0 (zero). Please set the auto-zero setting time so that it is longer than the interval of the slowest input signal. If the setting time is too long and there is no input signal, the rate at which the display value falls to 0 (zero) decrease, and output response rate may slow down.

Prescale

Displays values in required units or specific multiples by counting the number of input pulses, then multiplying the number of pulses or the length of pulses by variables (X×10y).

- E.g.: prescale value (α = 15) setting

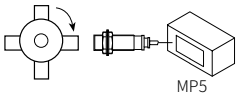

$$\begin{aligned} \text{Revolutions (rpm)} &= f \times \alpha \\ &= f \times 60 \times (1/N) \\ &= f \times 60 \times (1/4) \\ &= f \times 60 \times 0.25 \\ &= f \times 15 \end{aligned}$$

- f: the number of input pulses per second [Hz]
- α: prescale value
- N: the number of pulses per revolution

Set mantissa (X) as 1.5000, and exponent (Y) as 1 for prescale value (α)=15. The same display value can be obtained with a value set as X=0.1500, and Y=2

Example of Input Connection

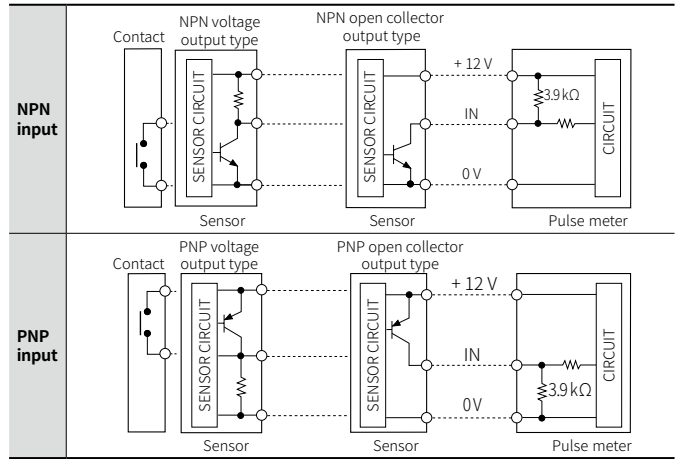

Segment Table

The segments displayed on the product indicate the following meanings. It may differ depending on the product.

7 segment	11 segment	12 segment	16 segment
0	0	0	0
1	1	1	1
2	2	2	2
3	3	3	3
4	4	4	4
5	5	5	5
6	6	6	6
7	7	7	7
8	8	8	8
9	9	9	9
A	A	A	A
b	b	b	b
c	c	c	c
d	d	d	d
E	E	E	E
F	F	F	F
G	G	G	G
H	H	H	H